

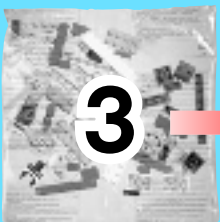

10224

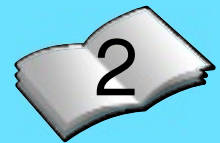

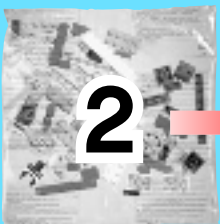



1



+

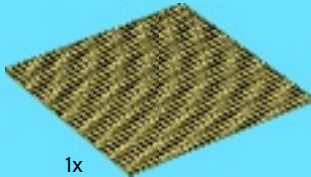

1x

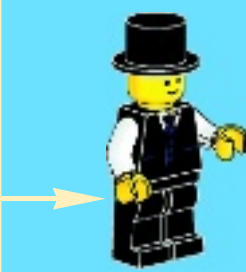
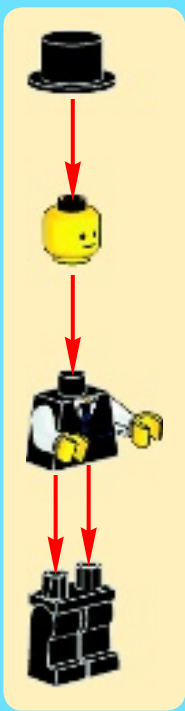



5x



2x

1

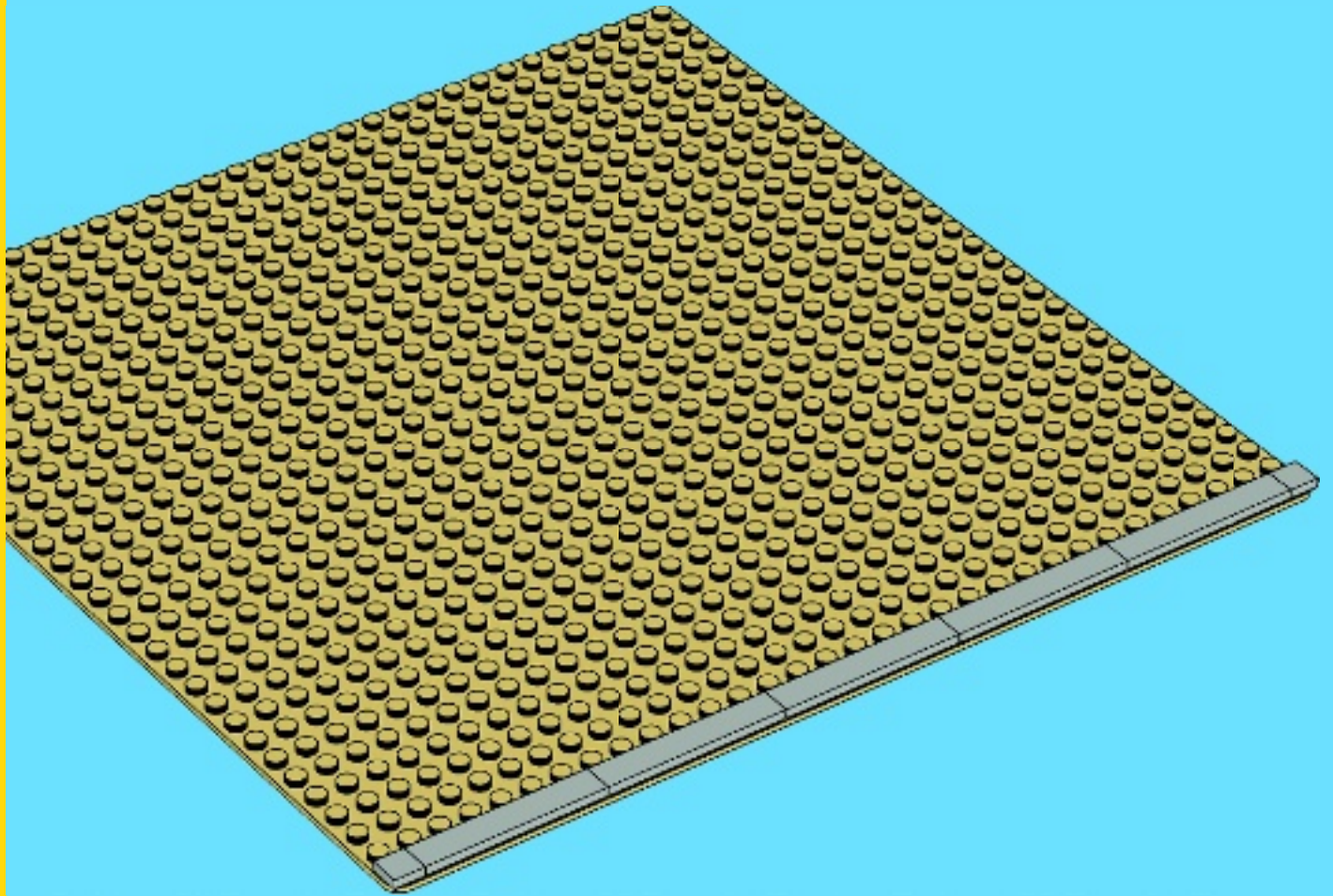

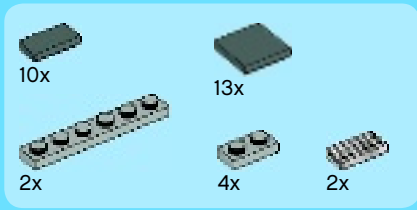

2

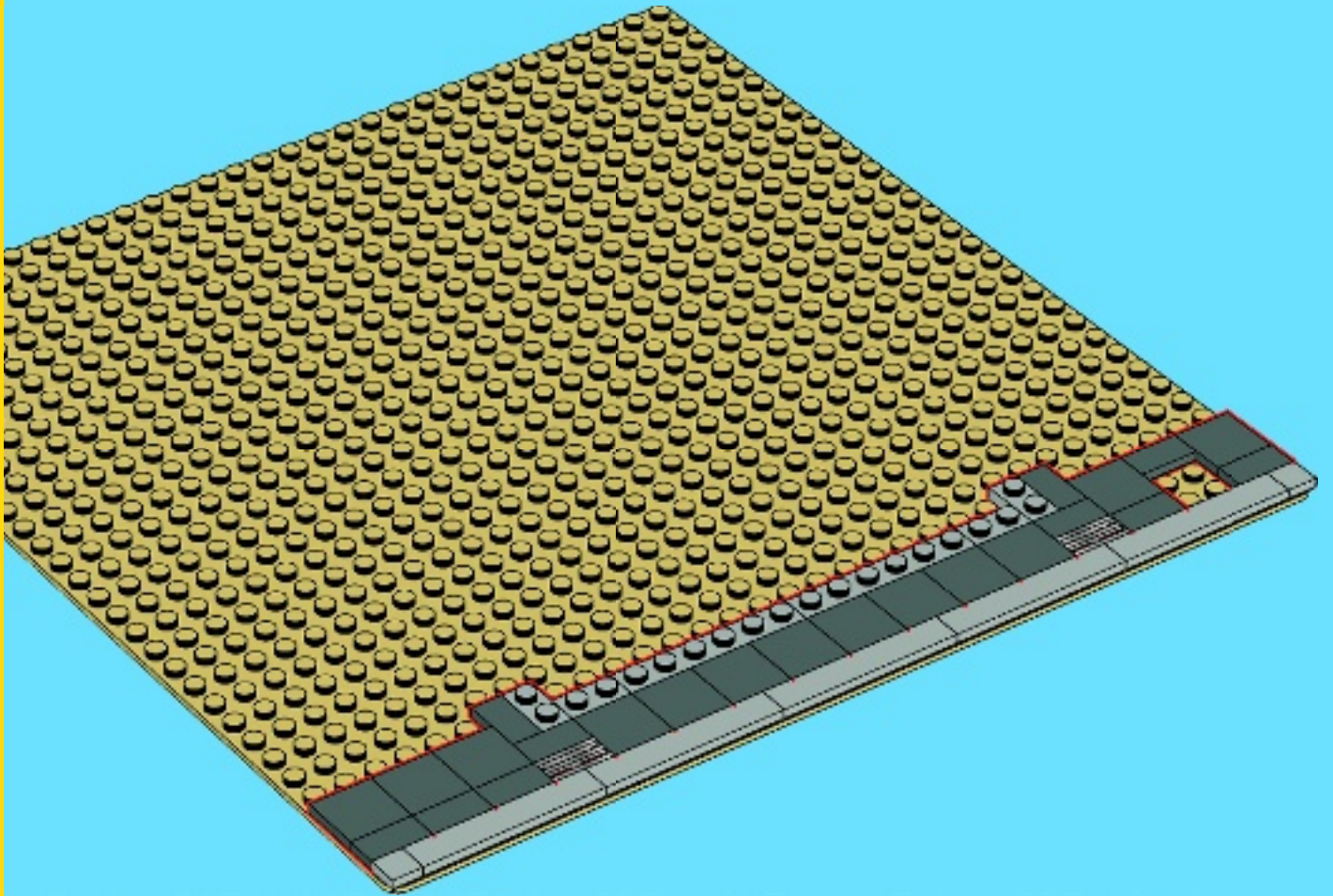

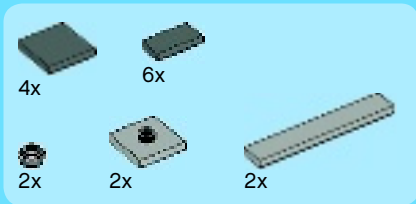

3

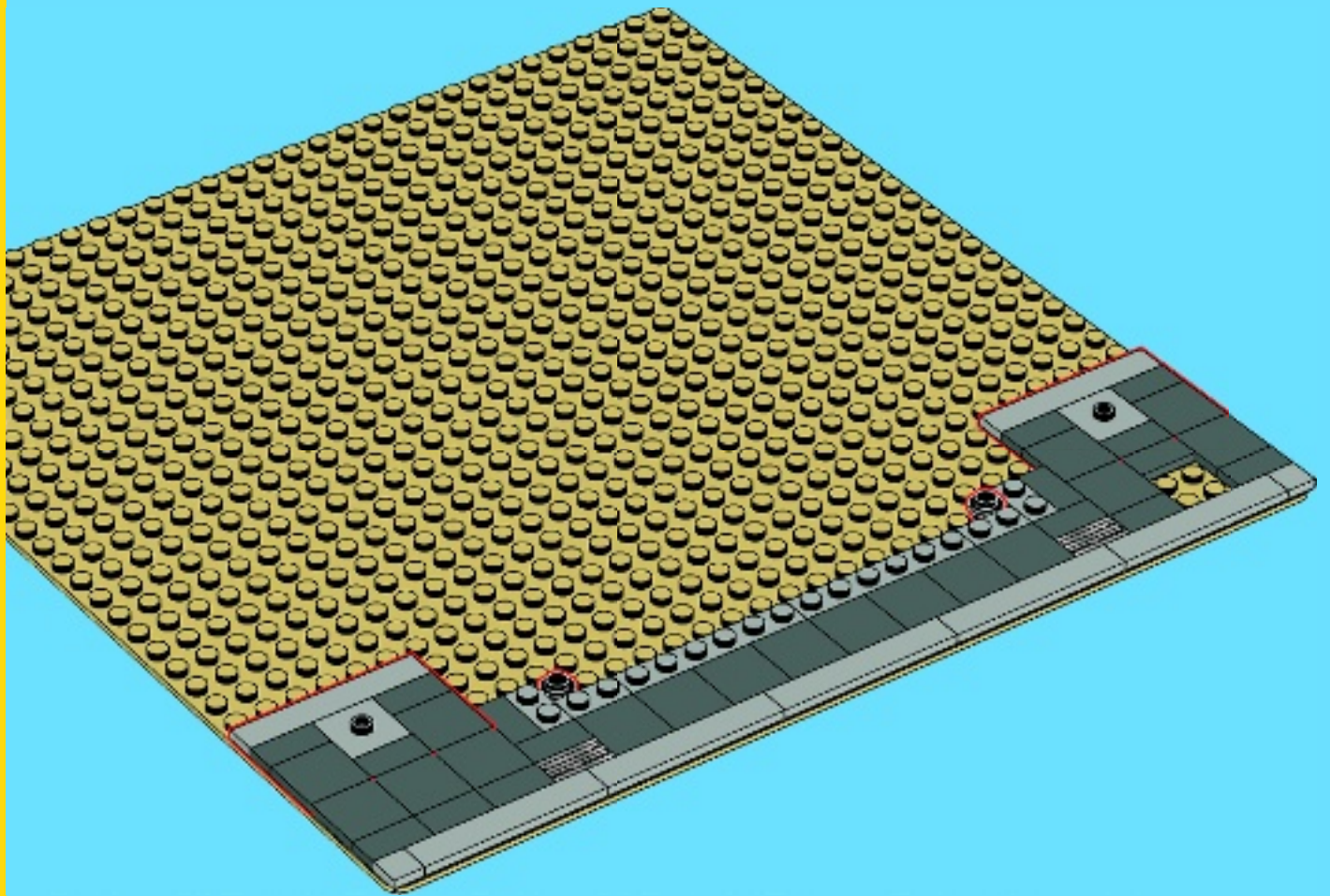

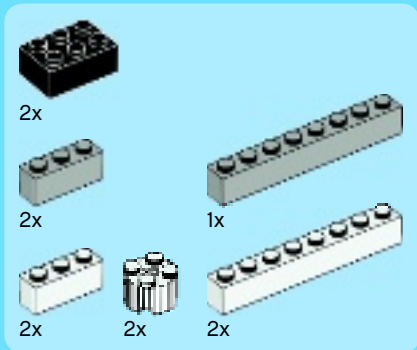

4

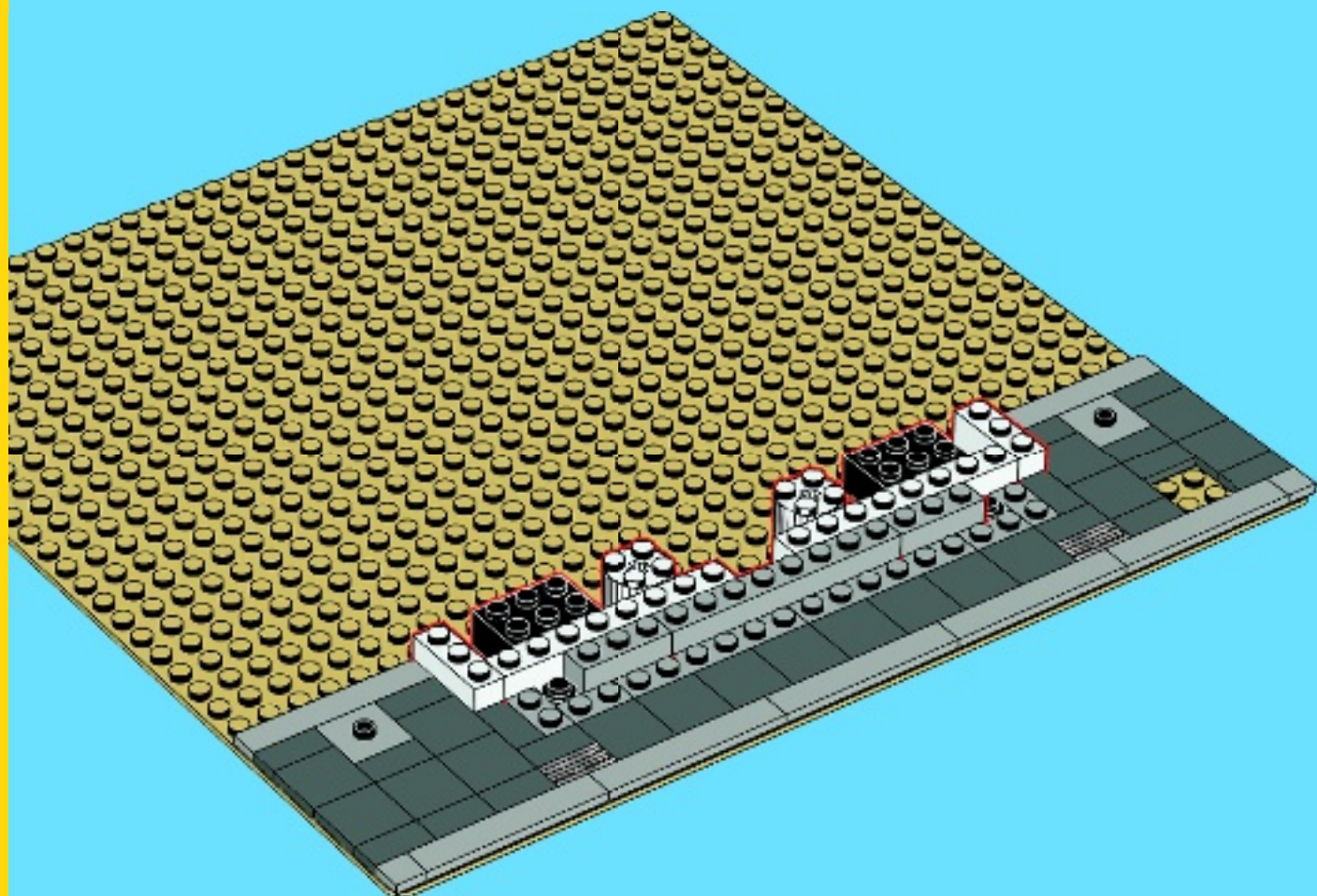

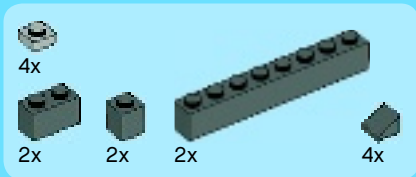

5

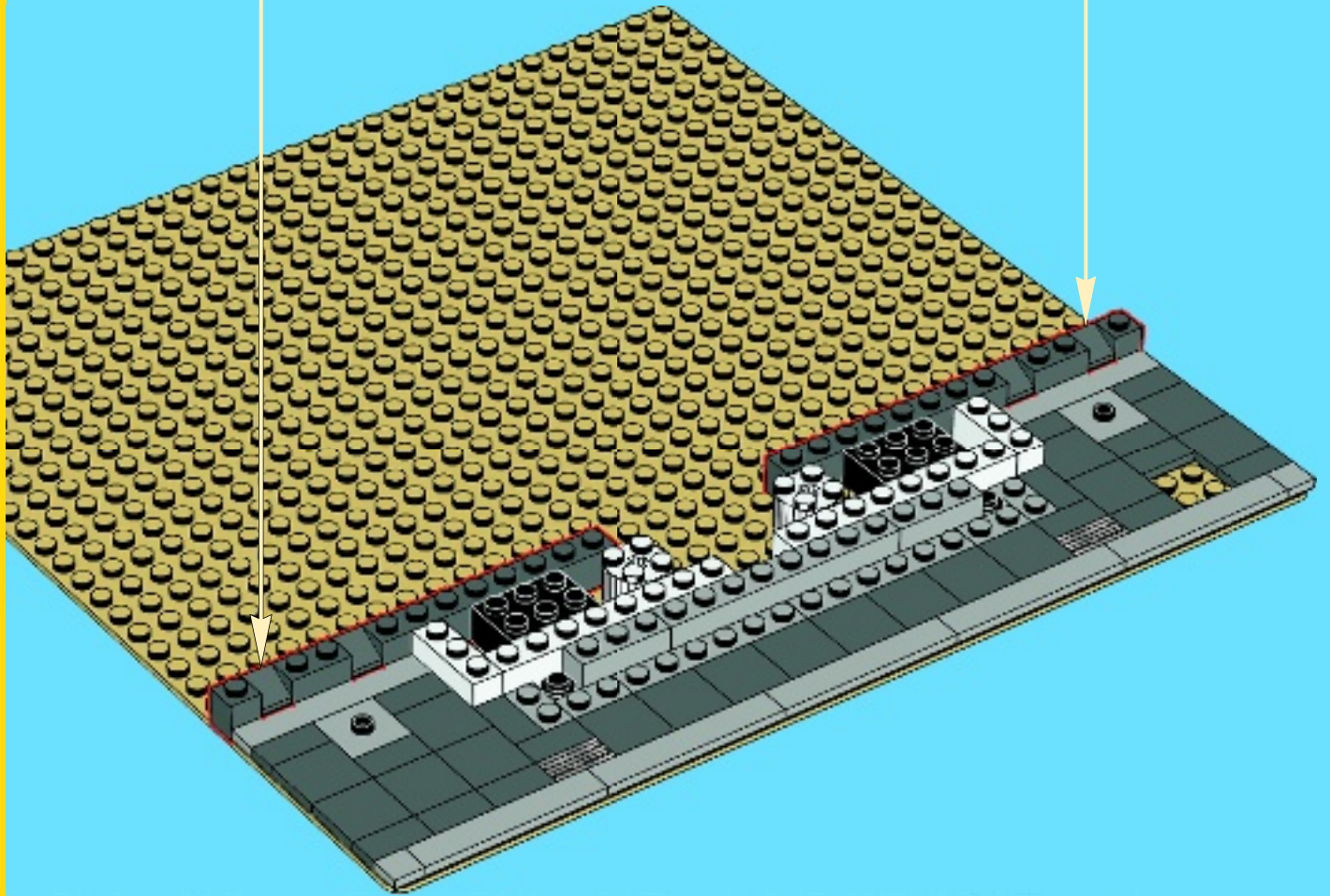
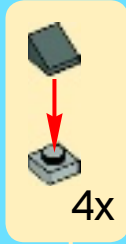

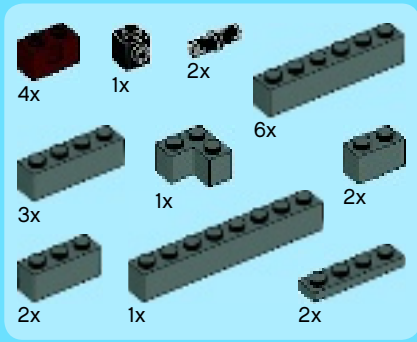

6

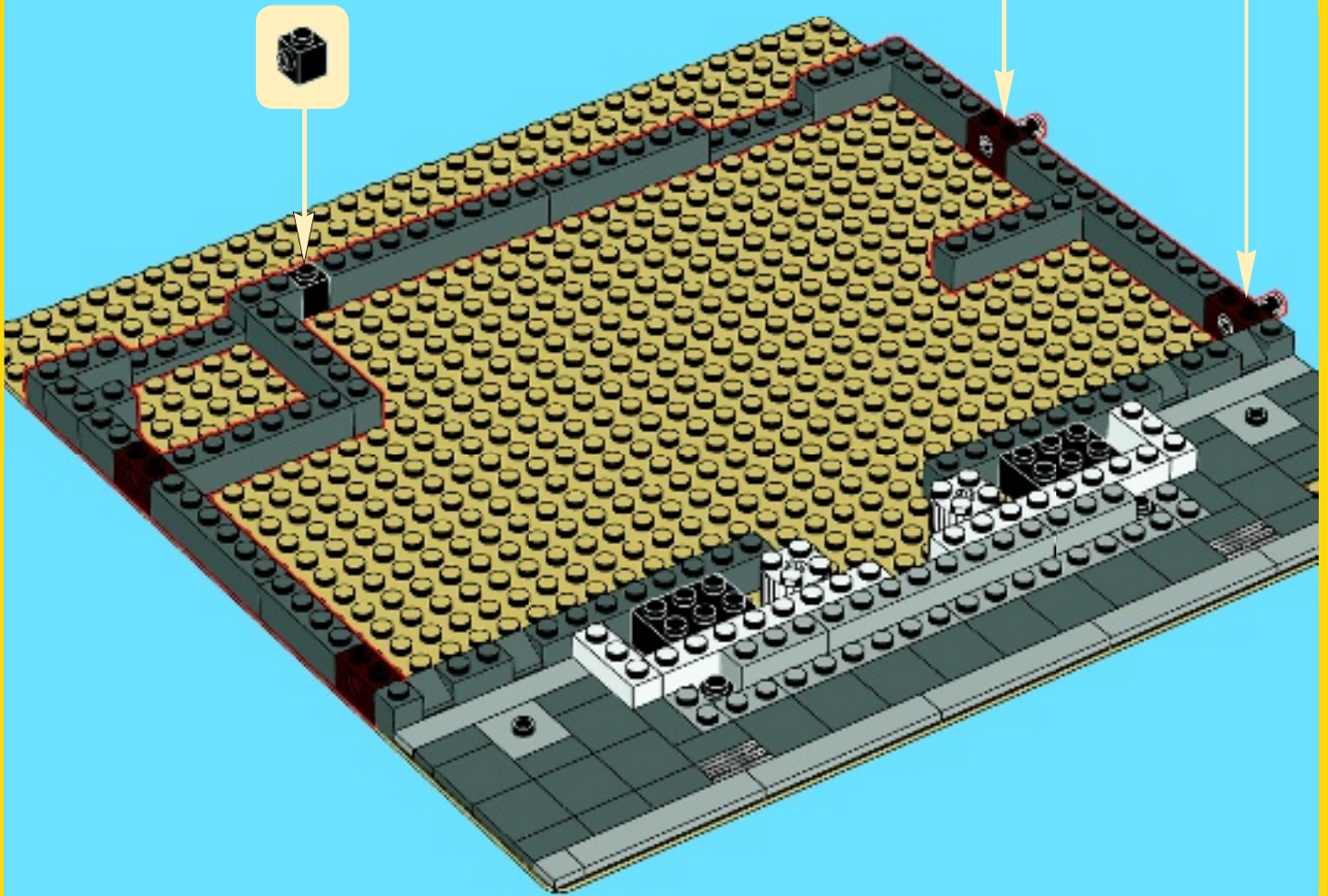
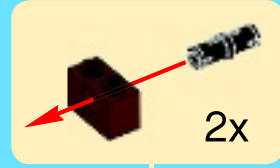

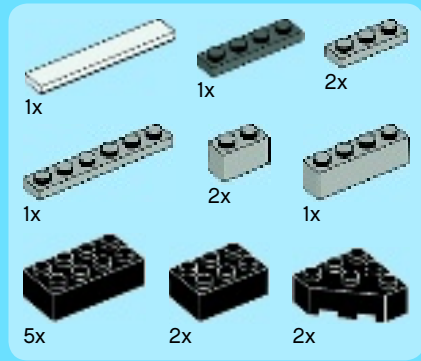

7

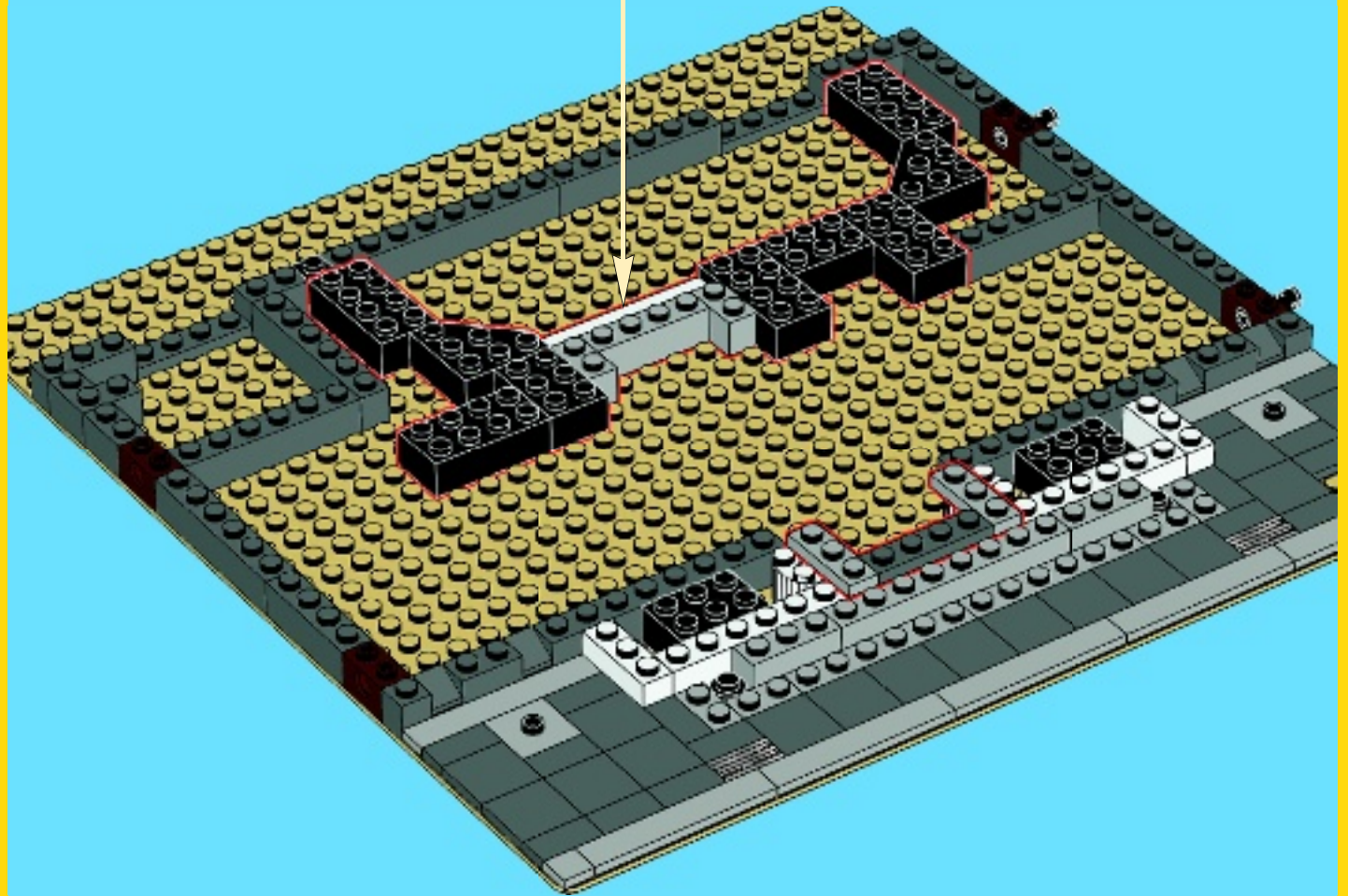
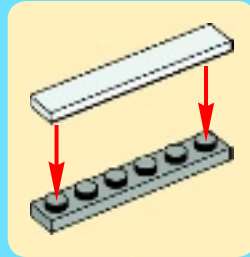

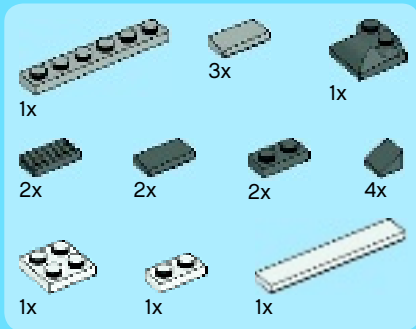

8

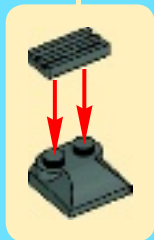
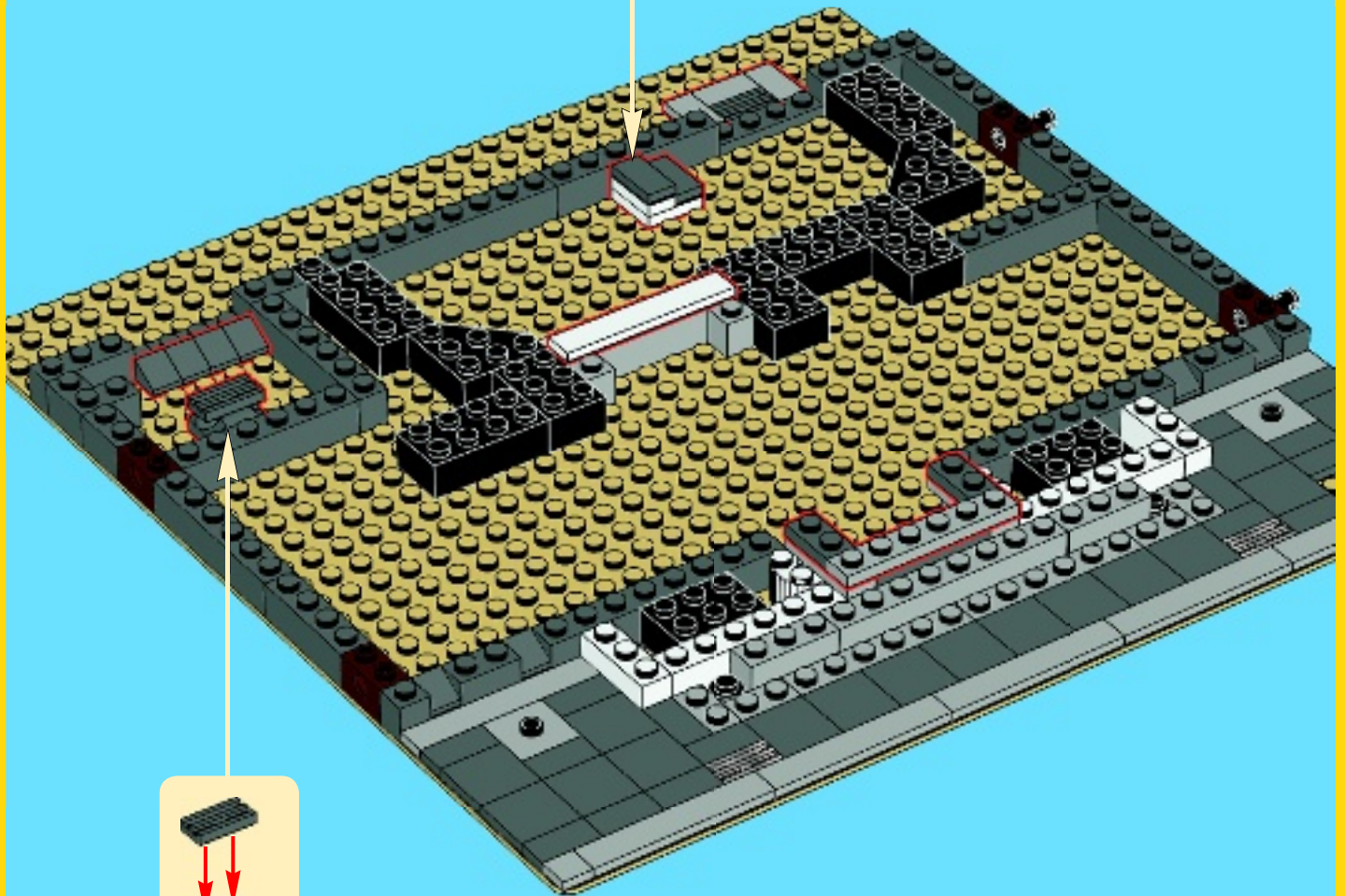
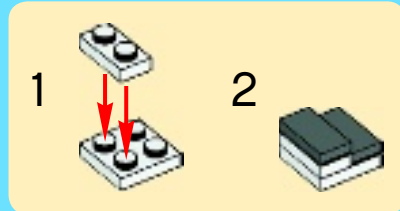

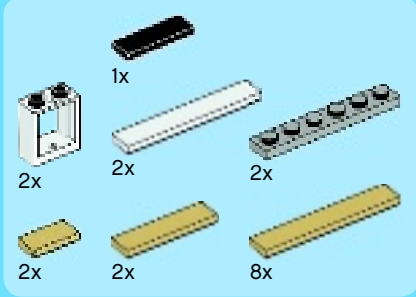

9

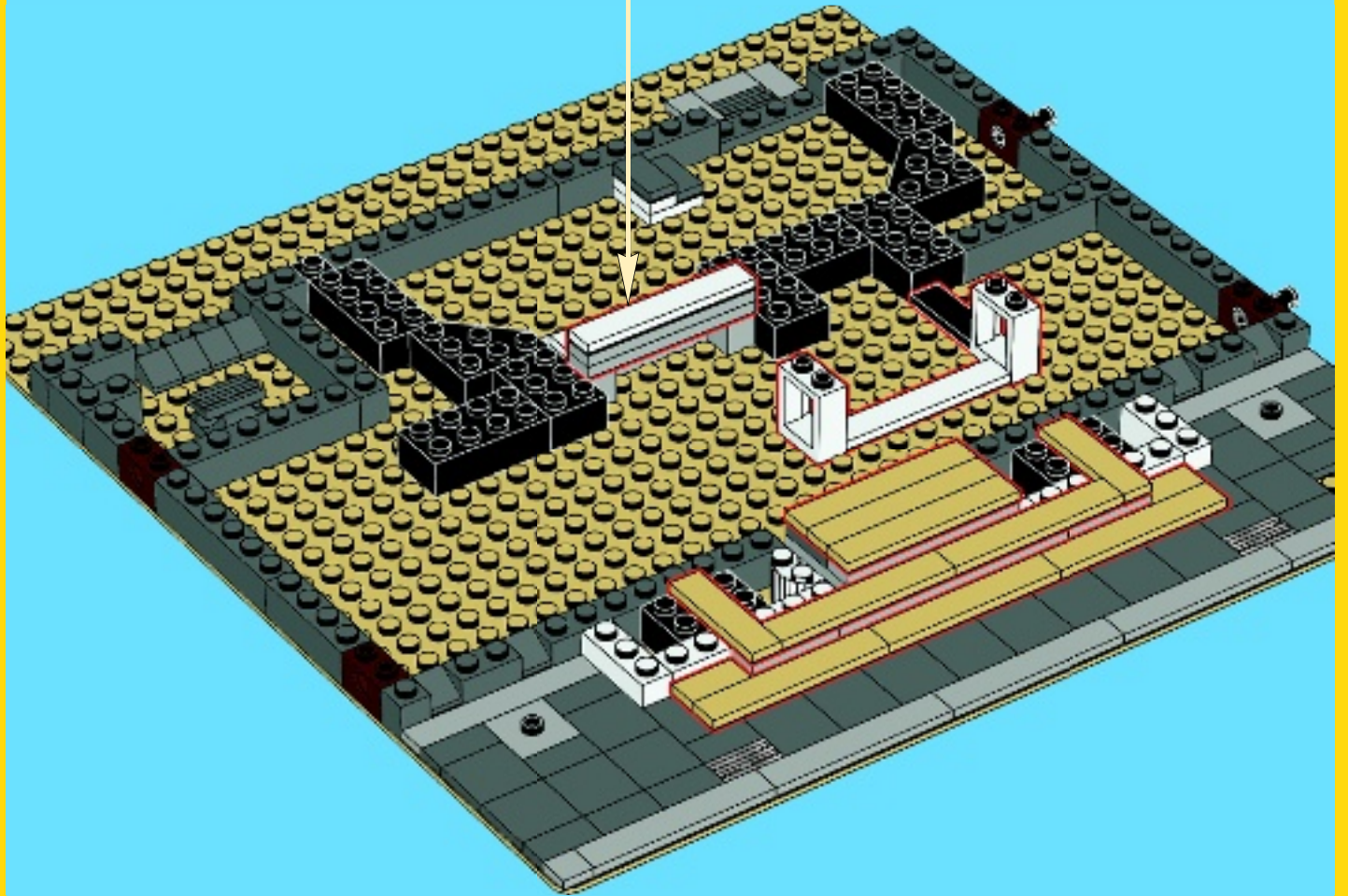
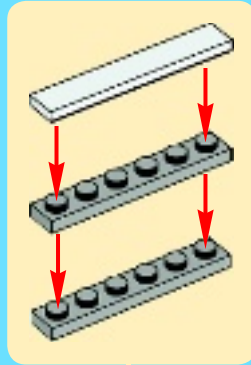

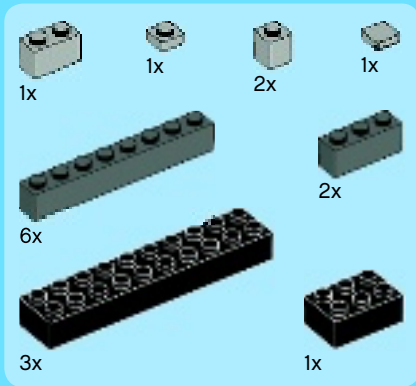

10

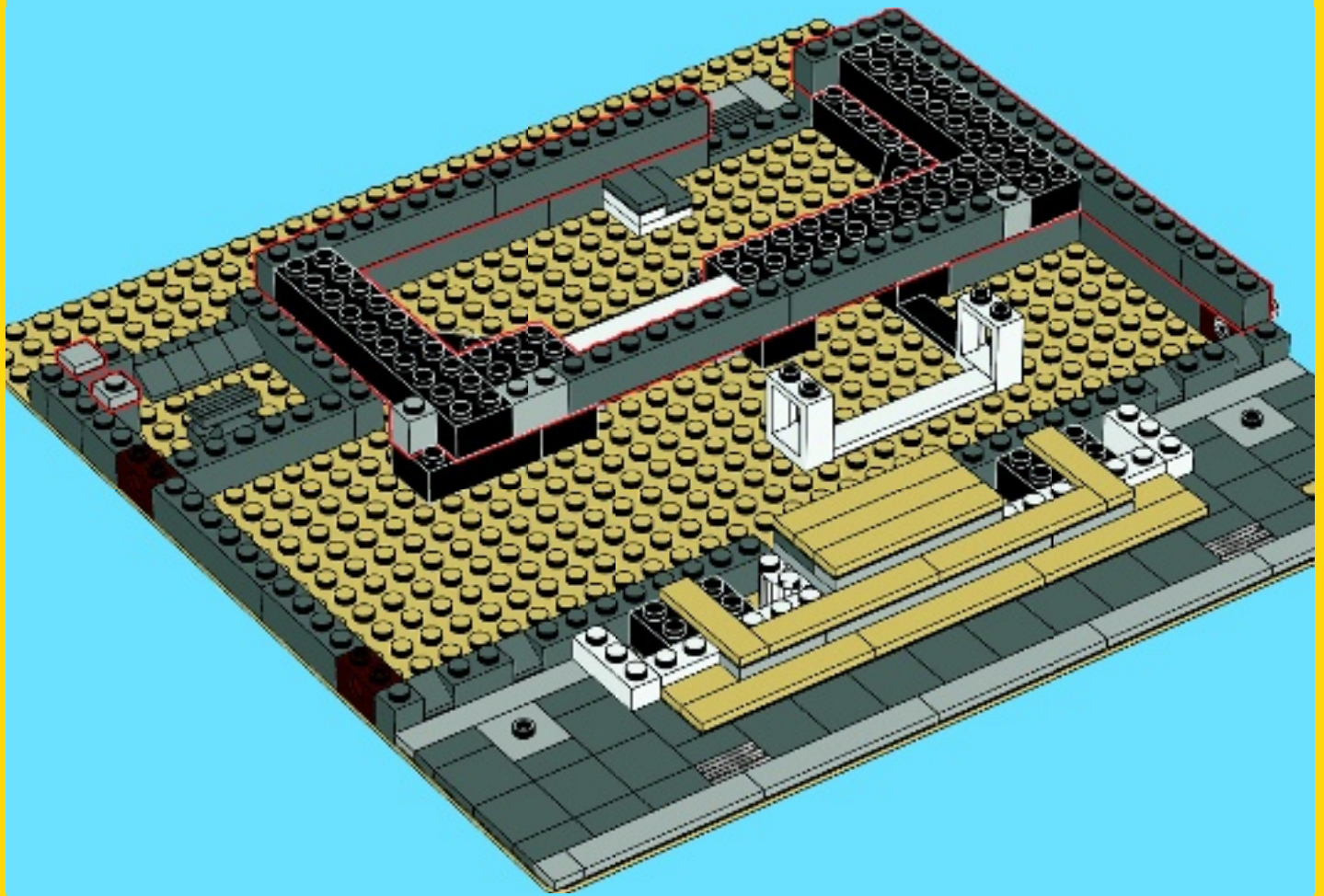

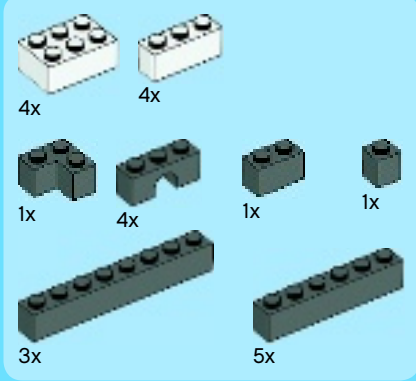

11

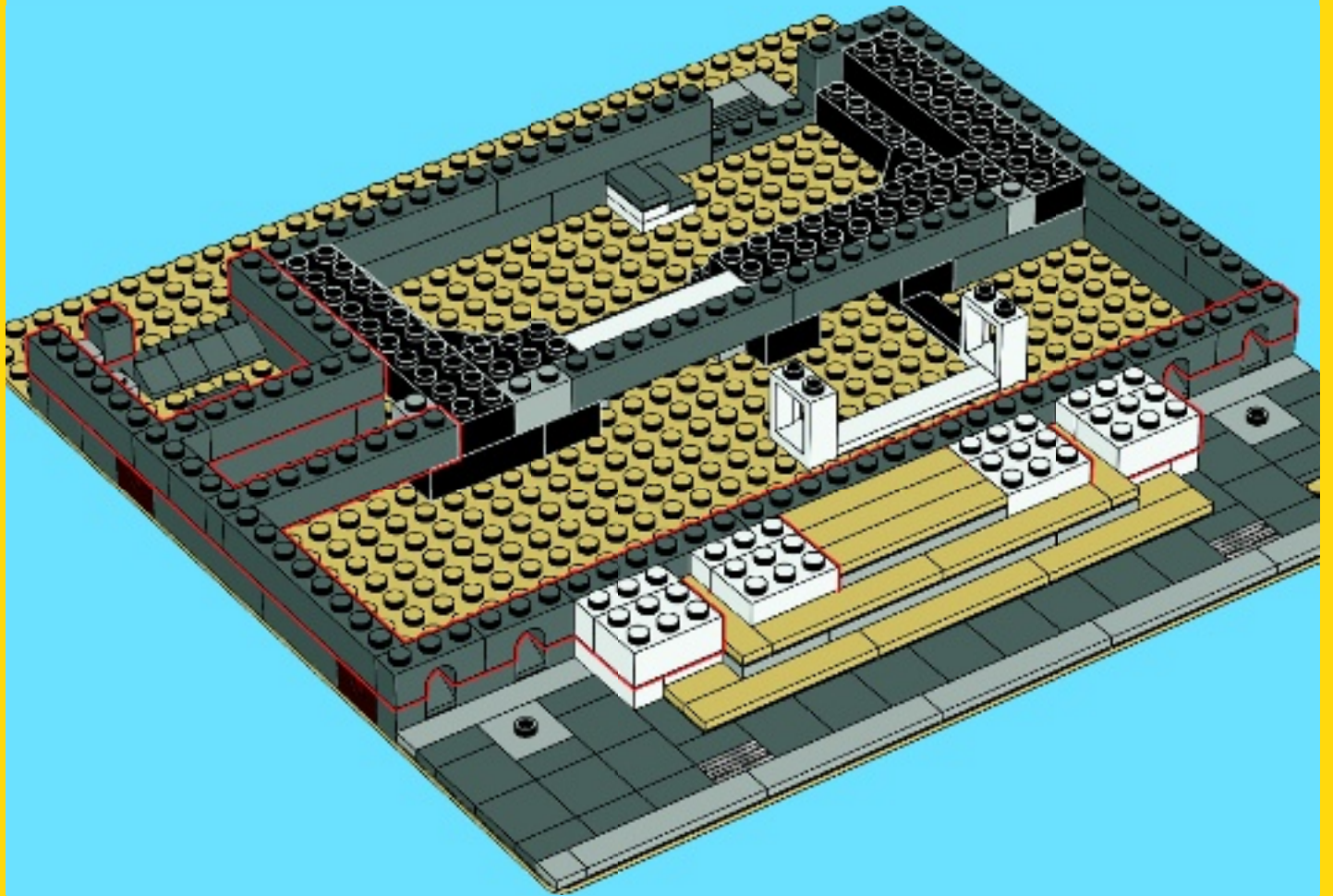

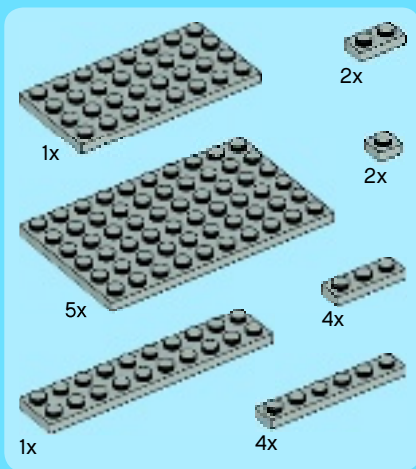

12

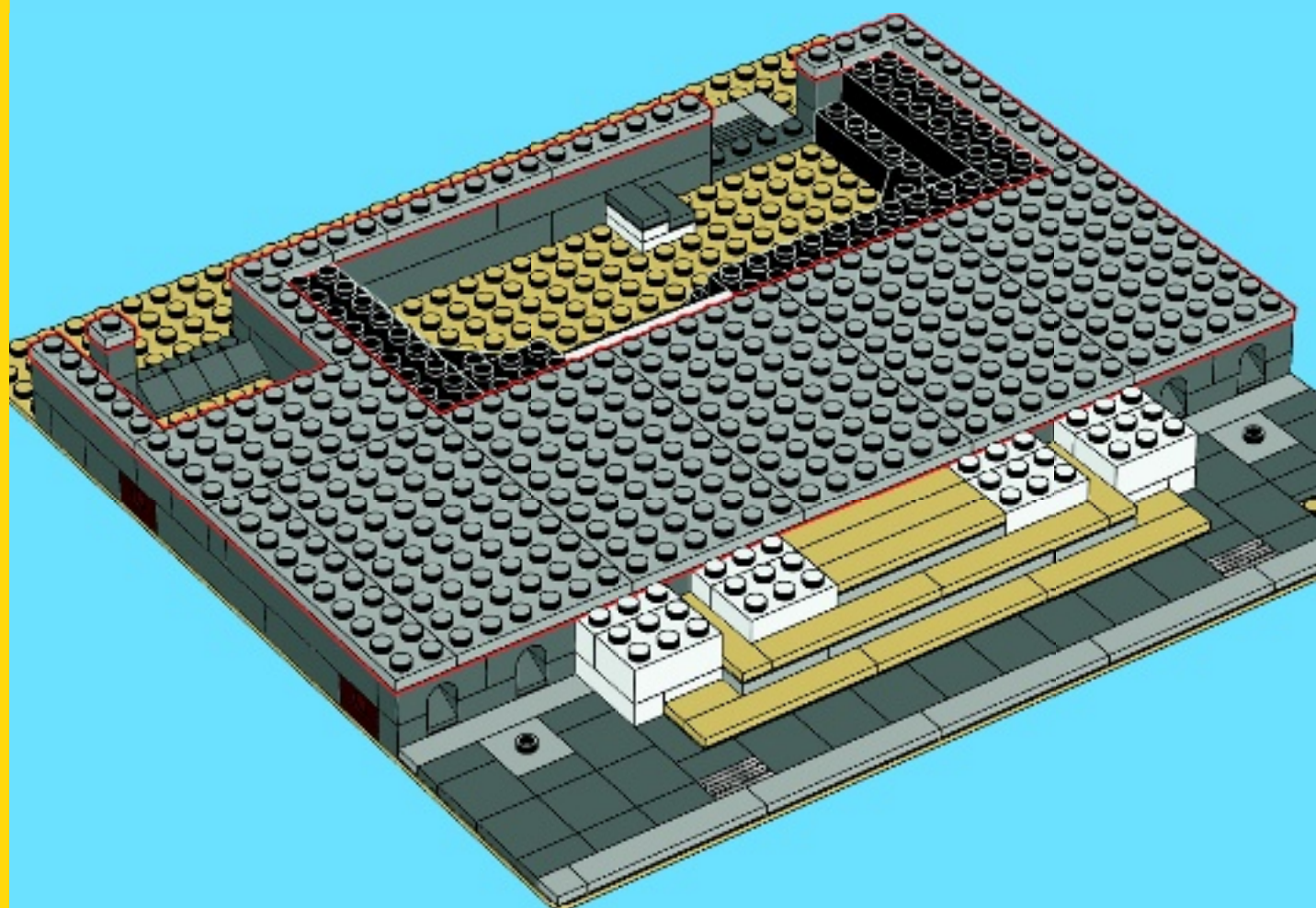

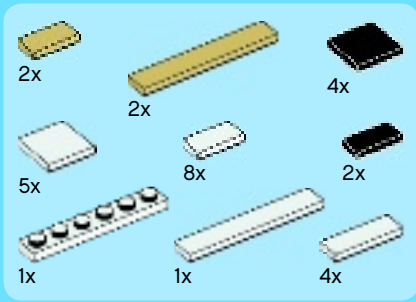

13

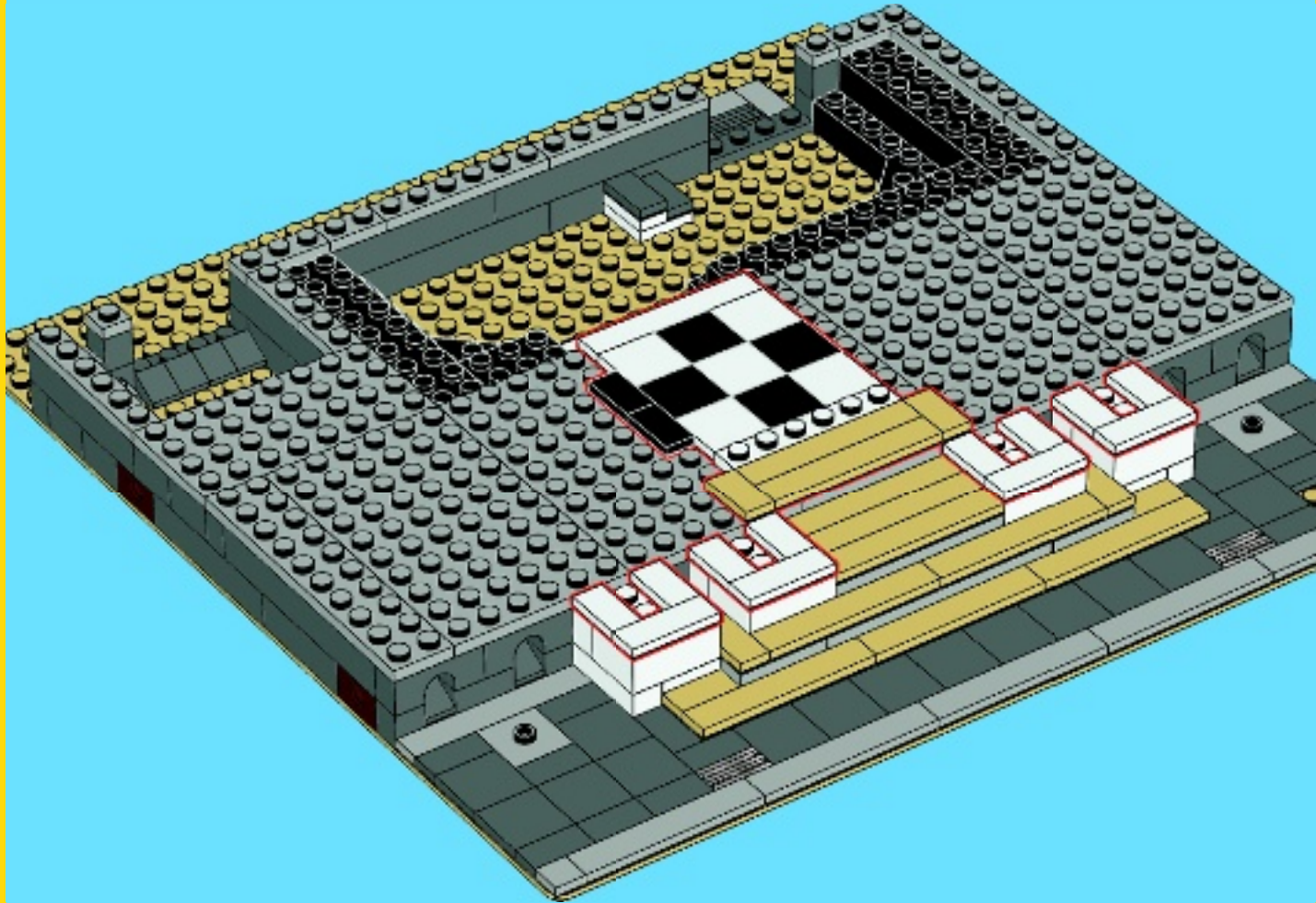

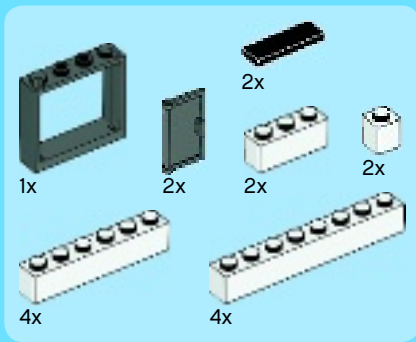

14

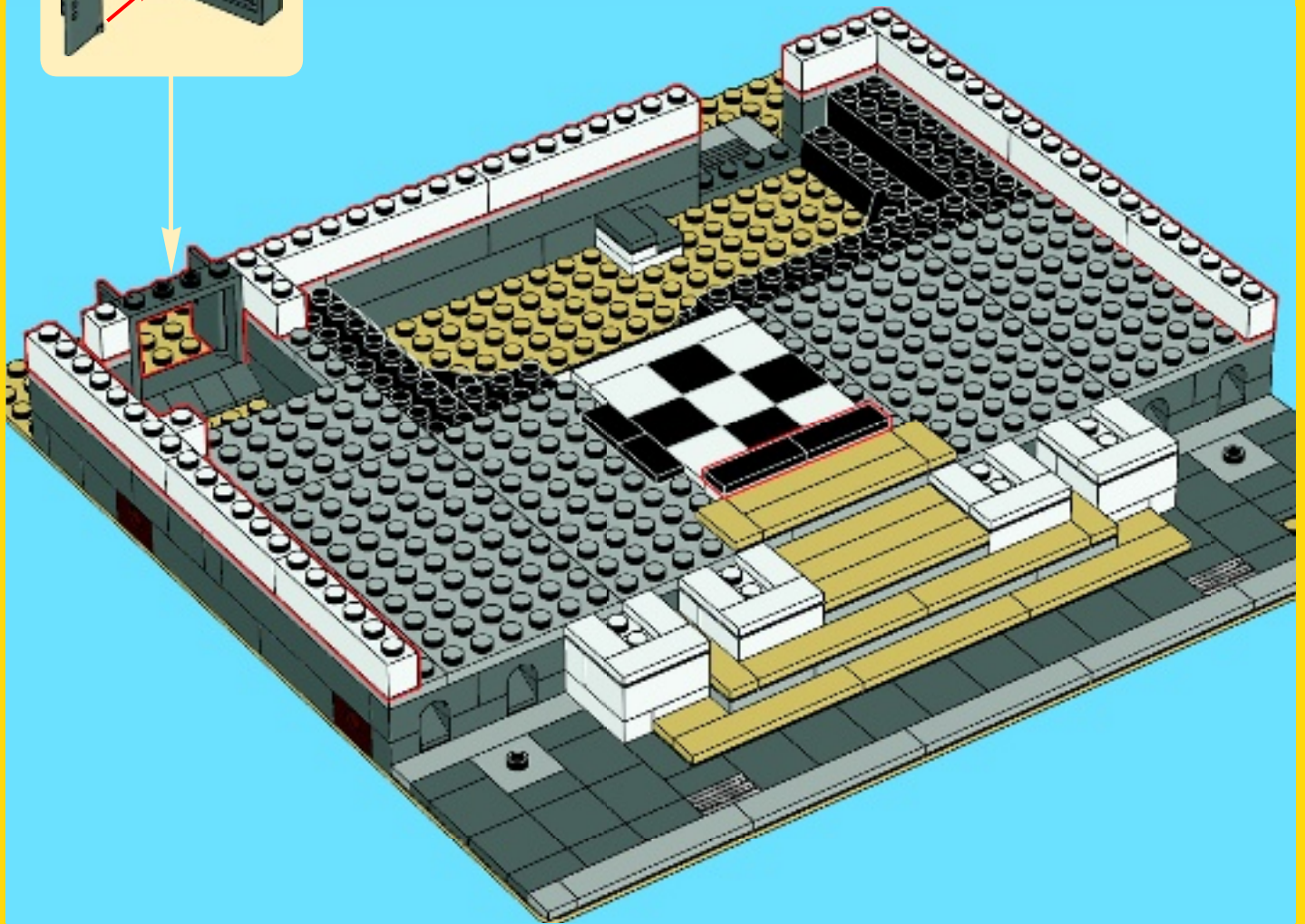
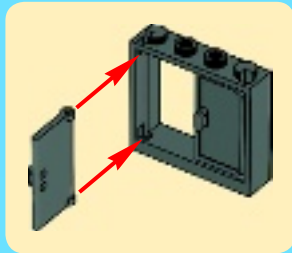

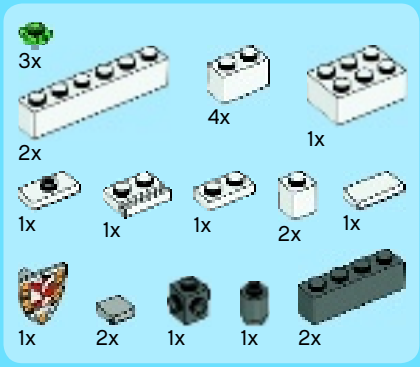

15

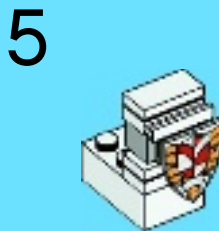
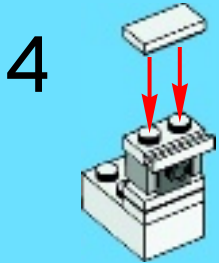
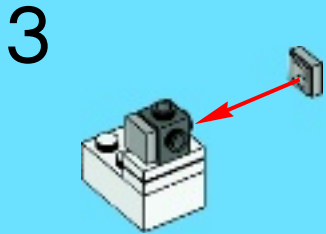
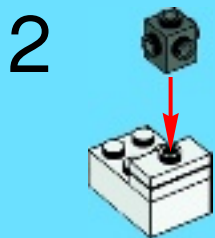
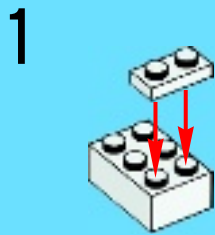

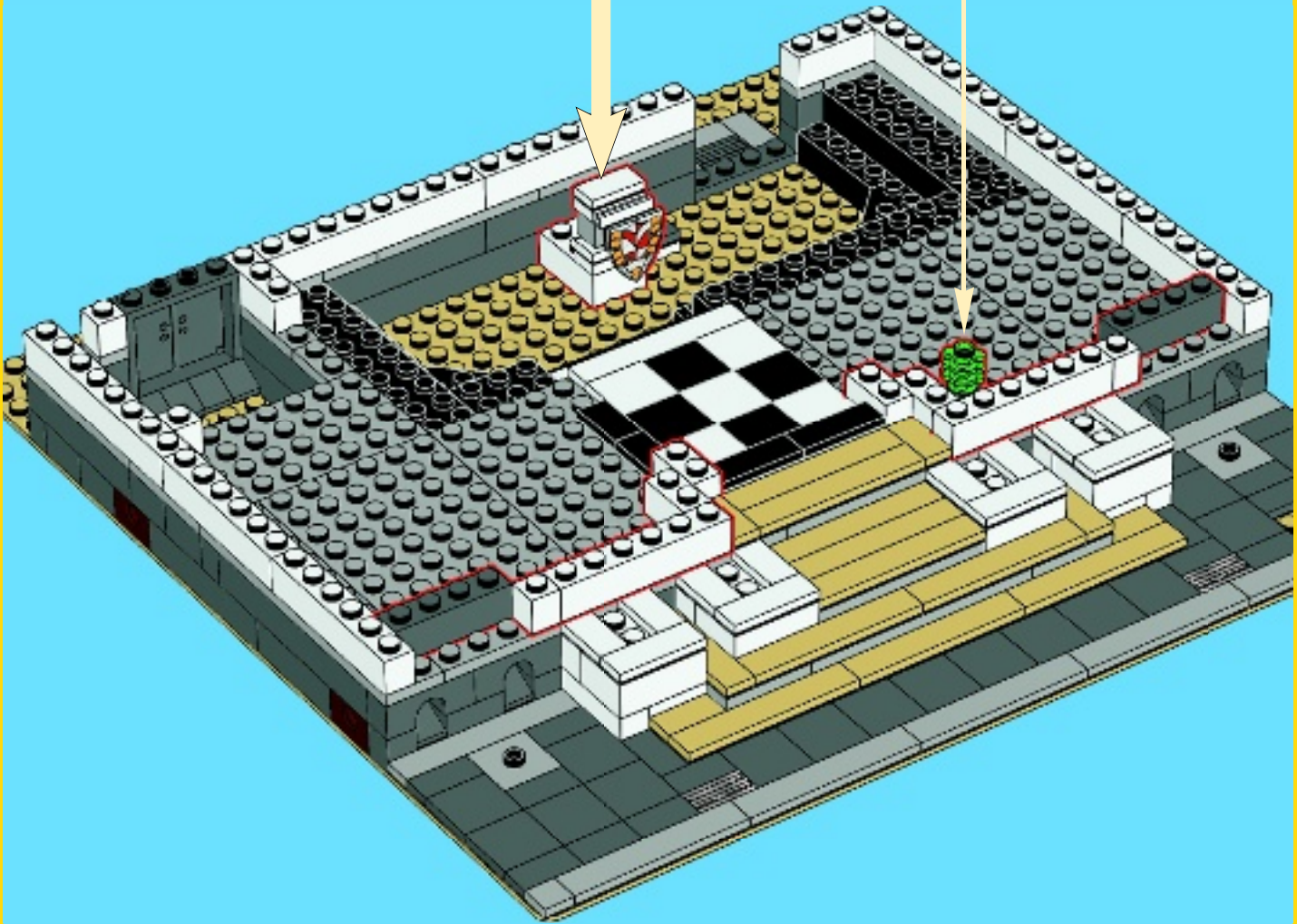
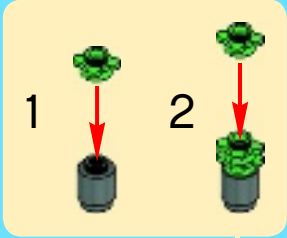

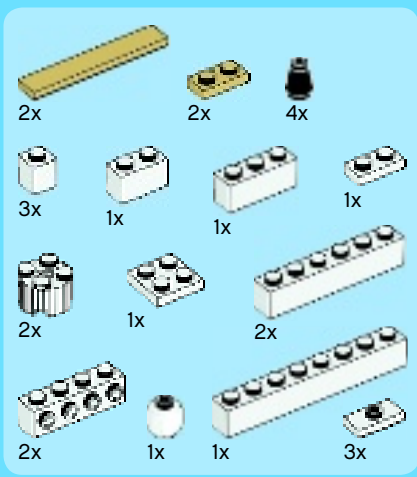

16

1

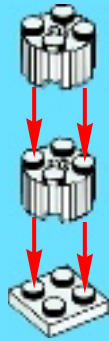

2

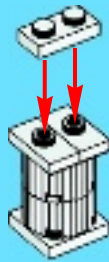

3

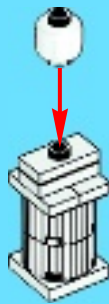

1

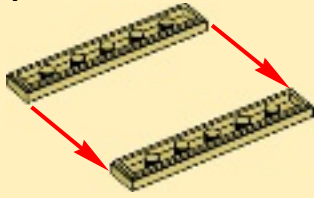

2

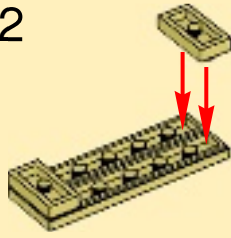

3

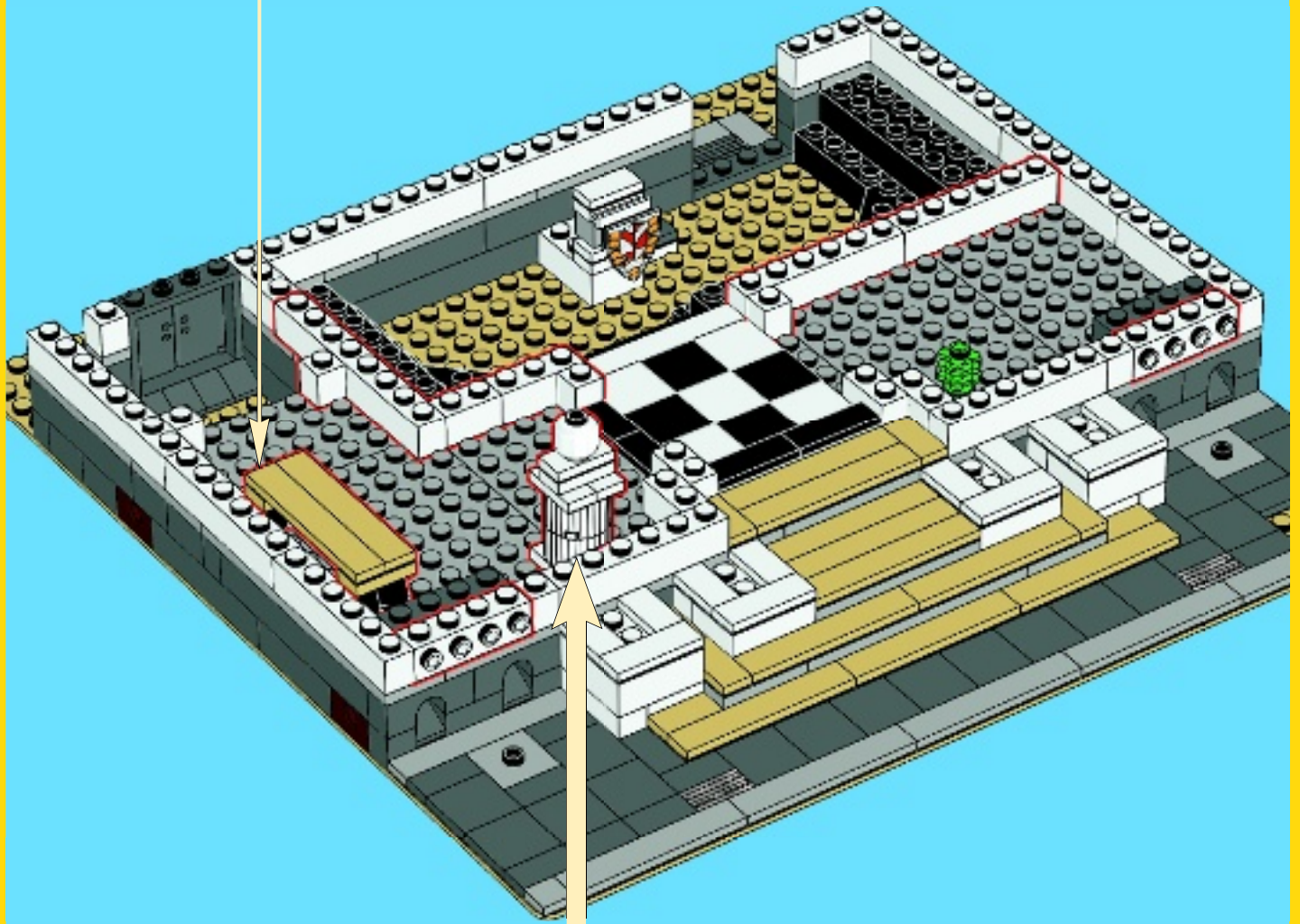

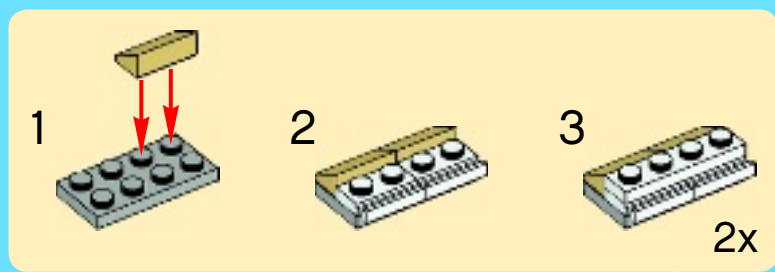
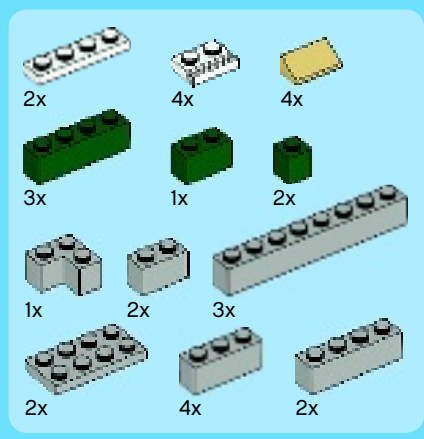

17

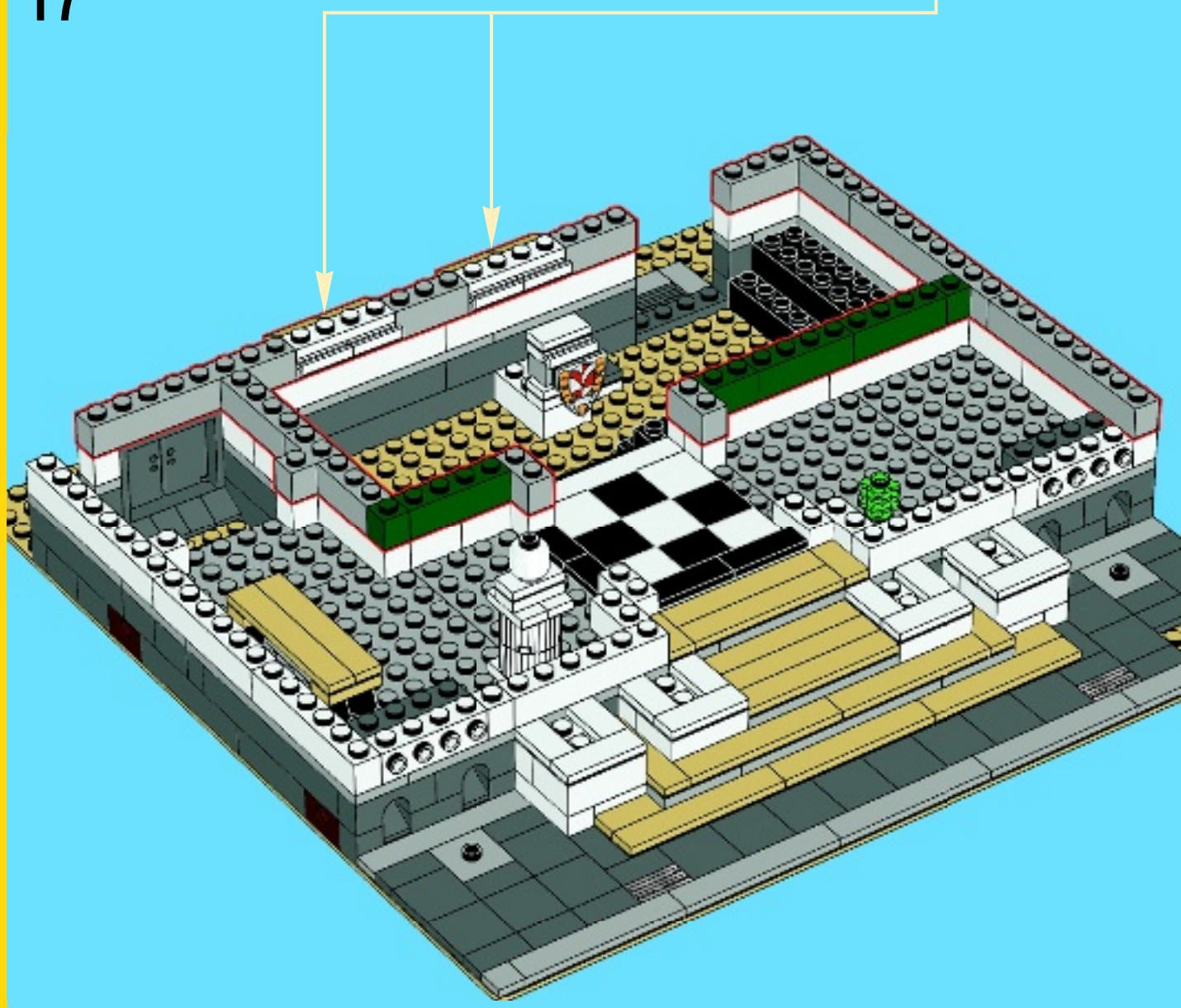

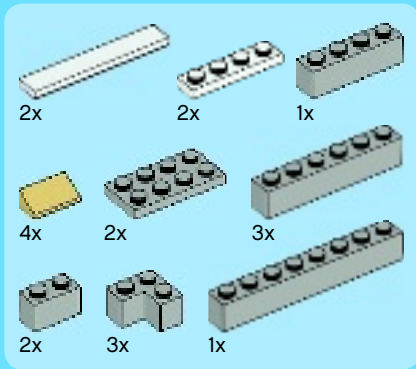

18

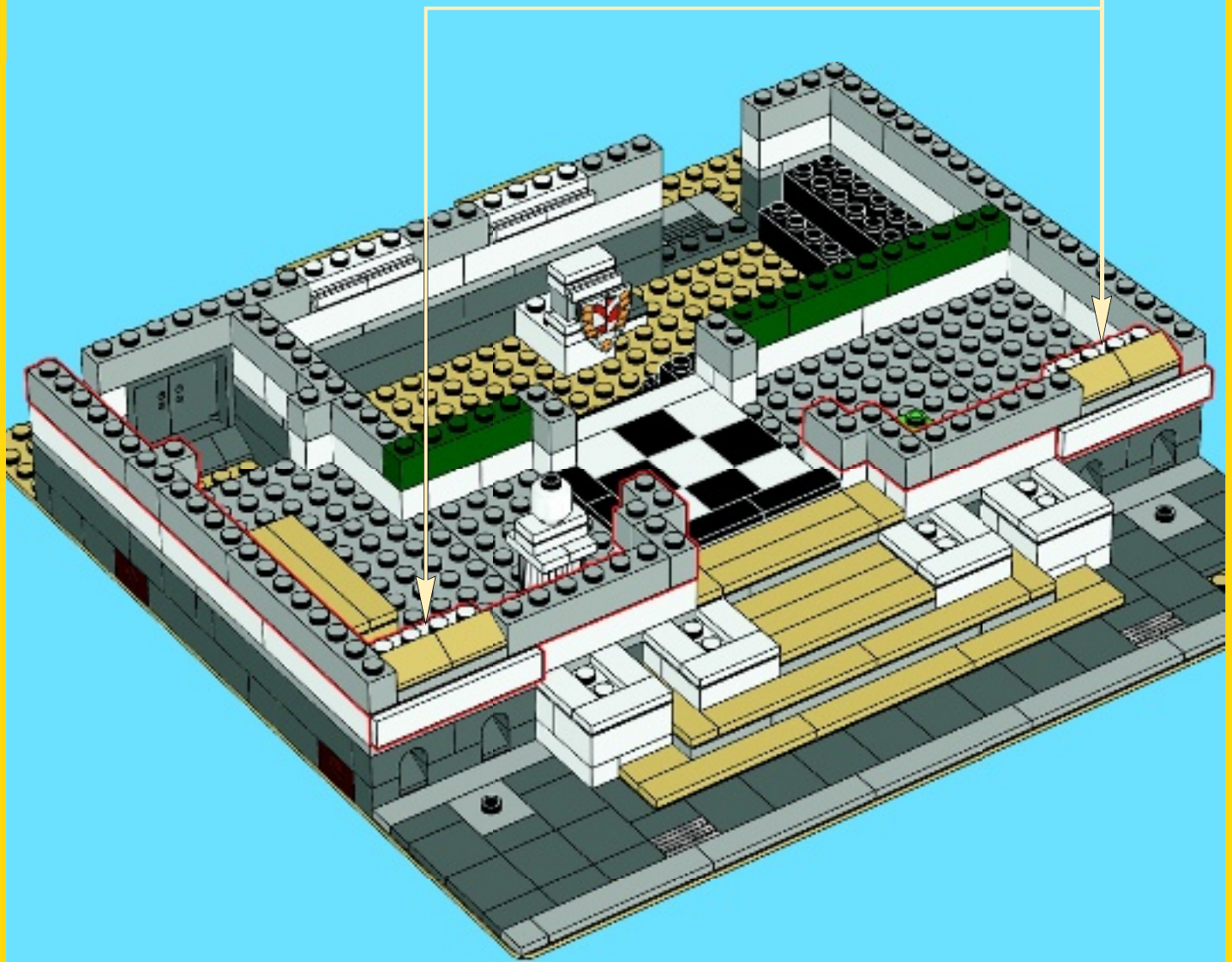
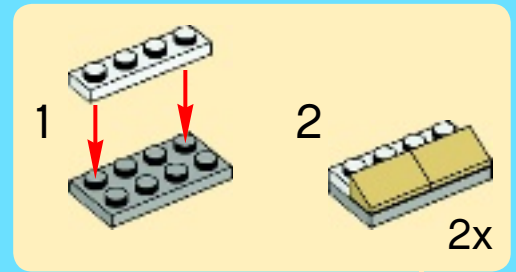

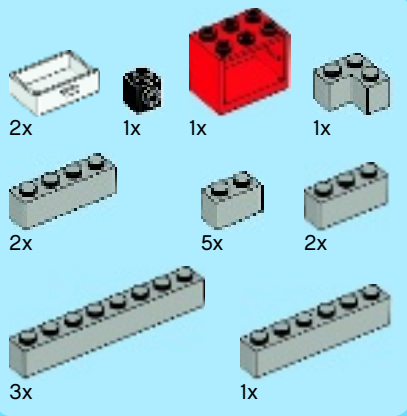

19

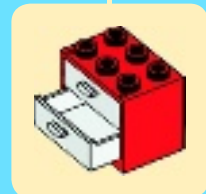
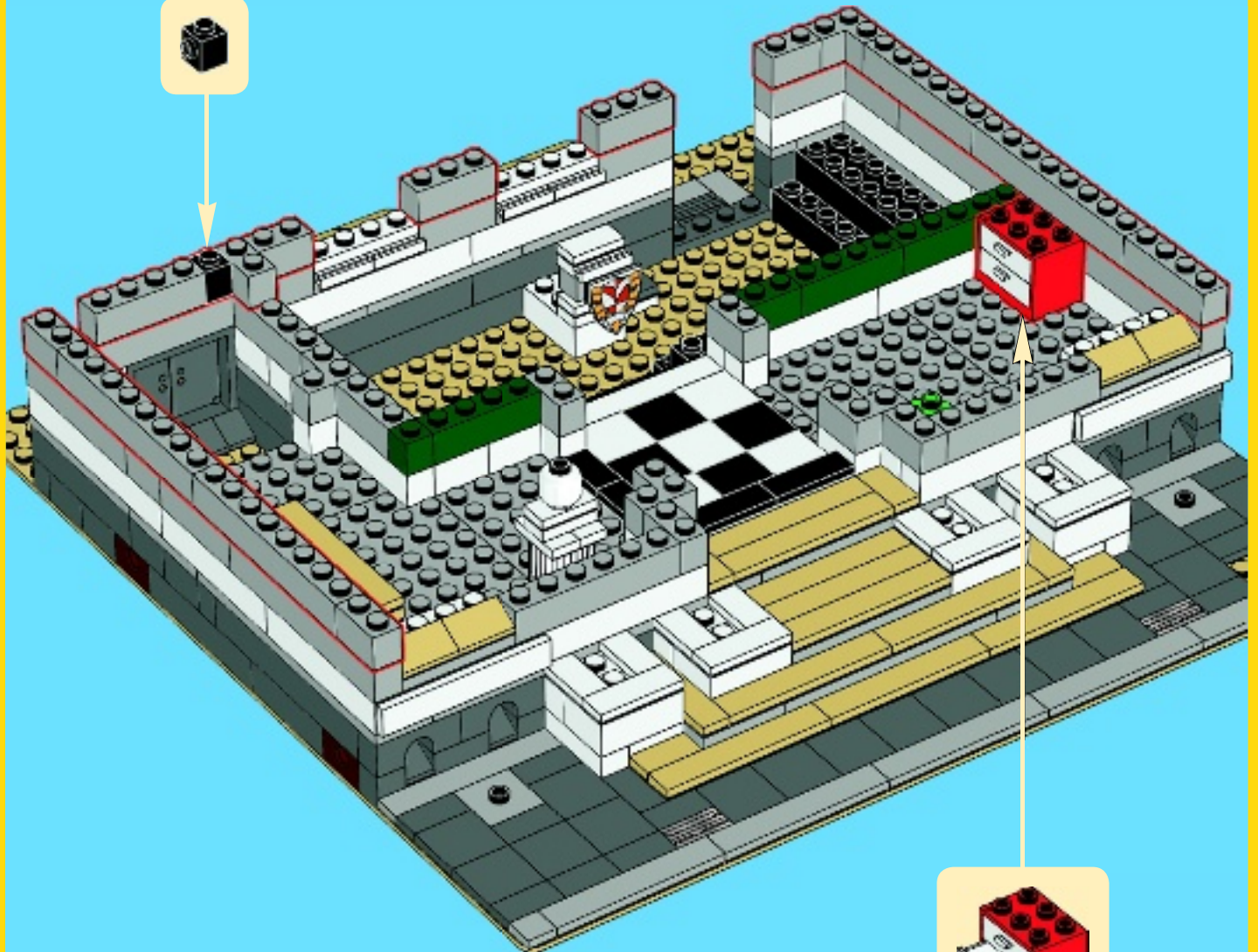

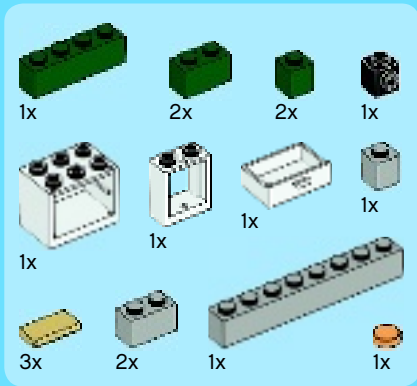

20

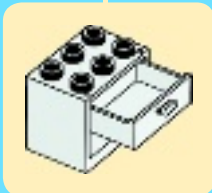
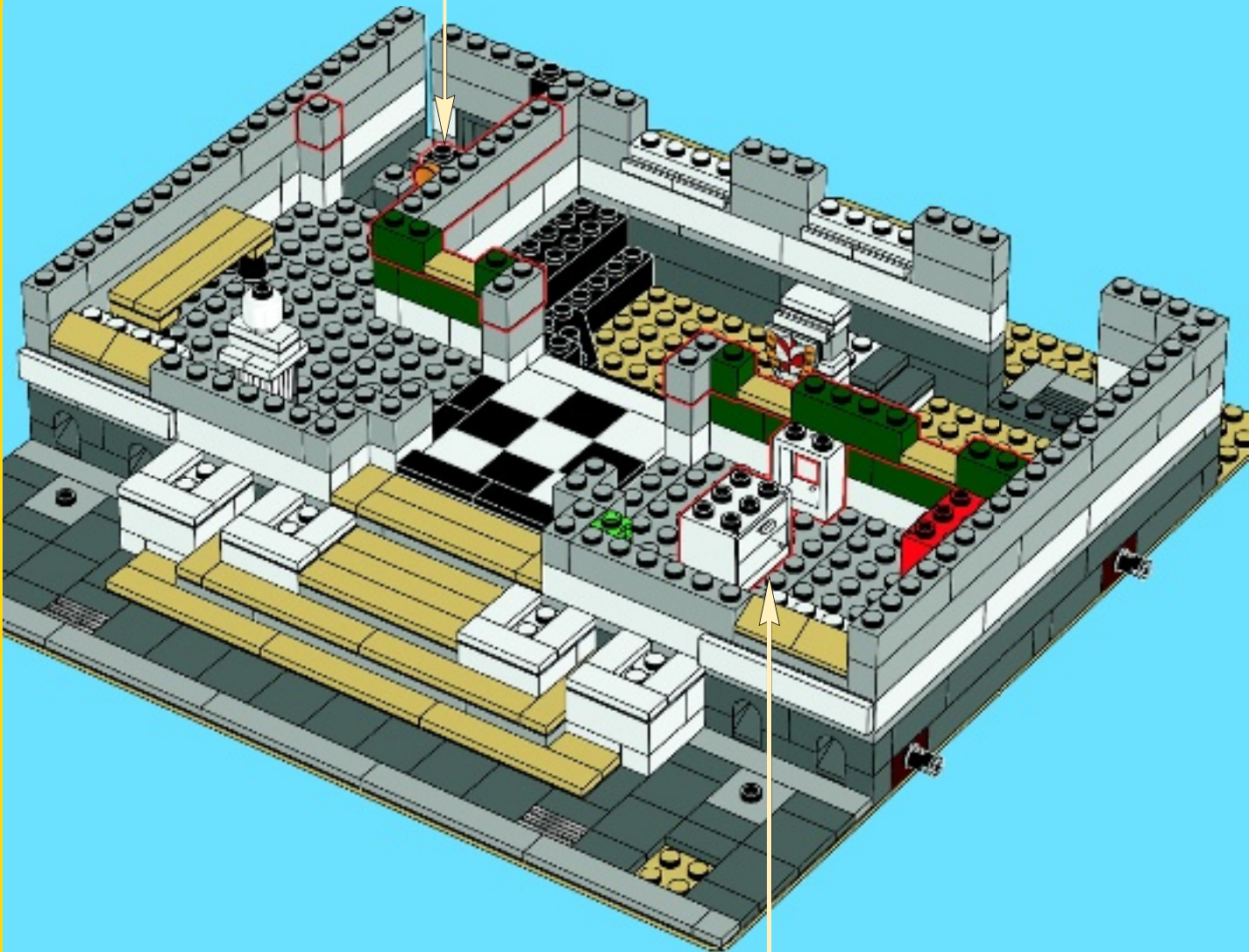

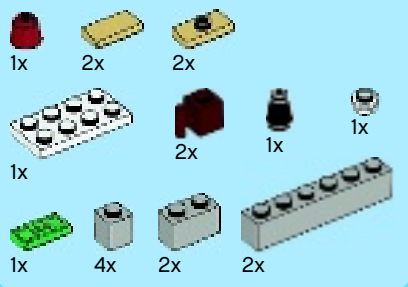

21

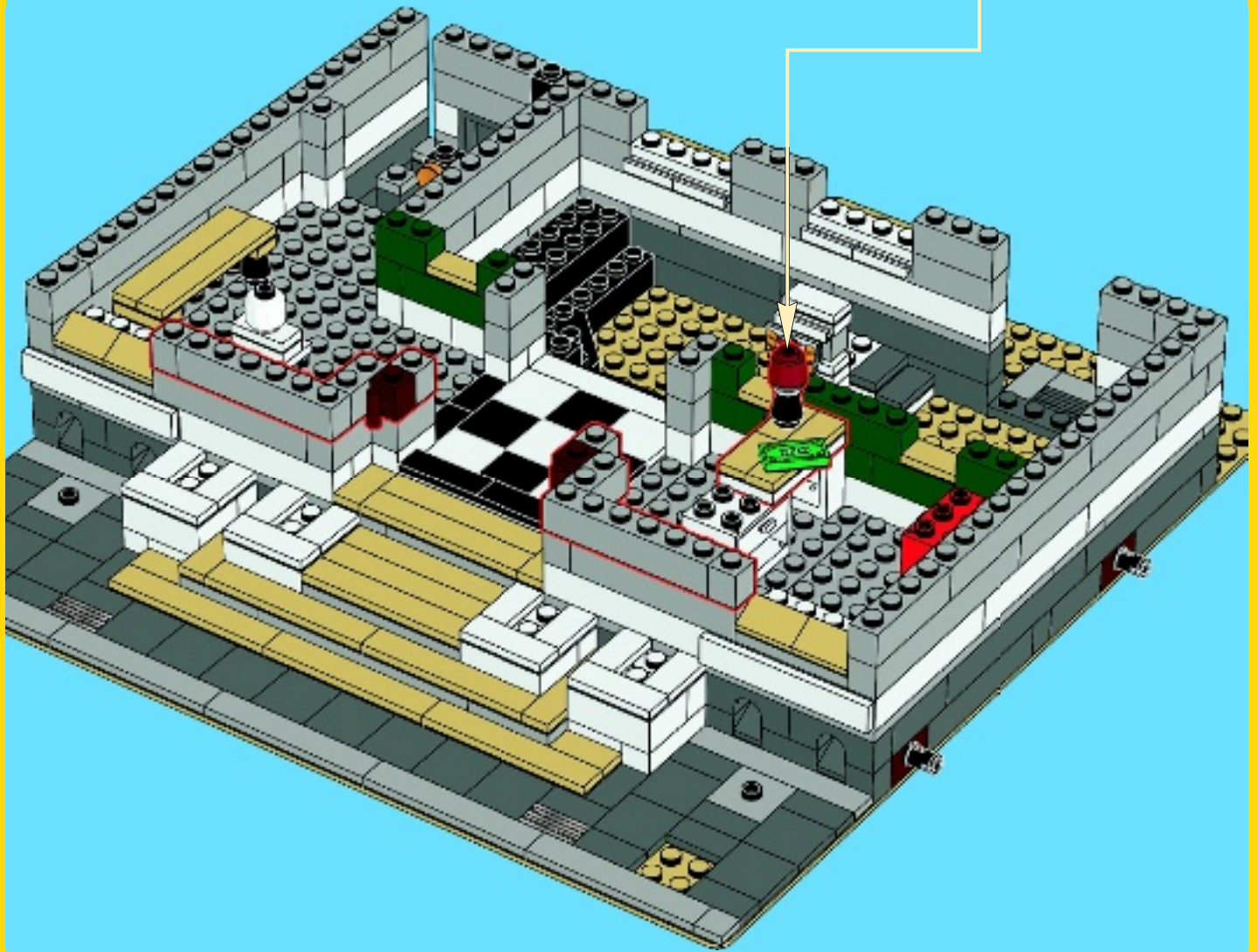
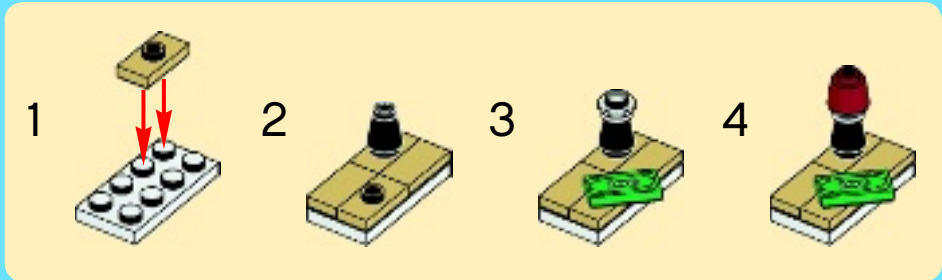

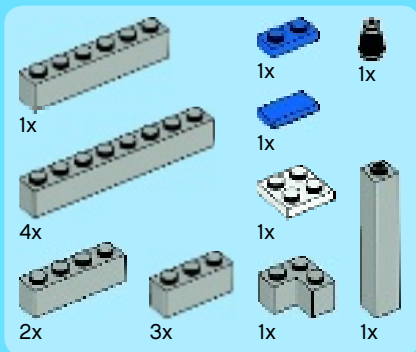

22

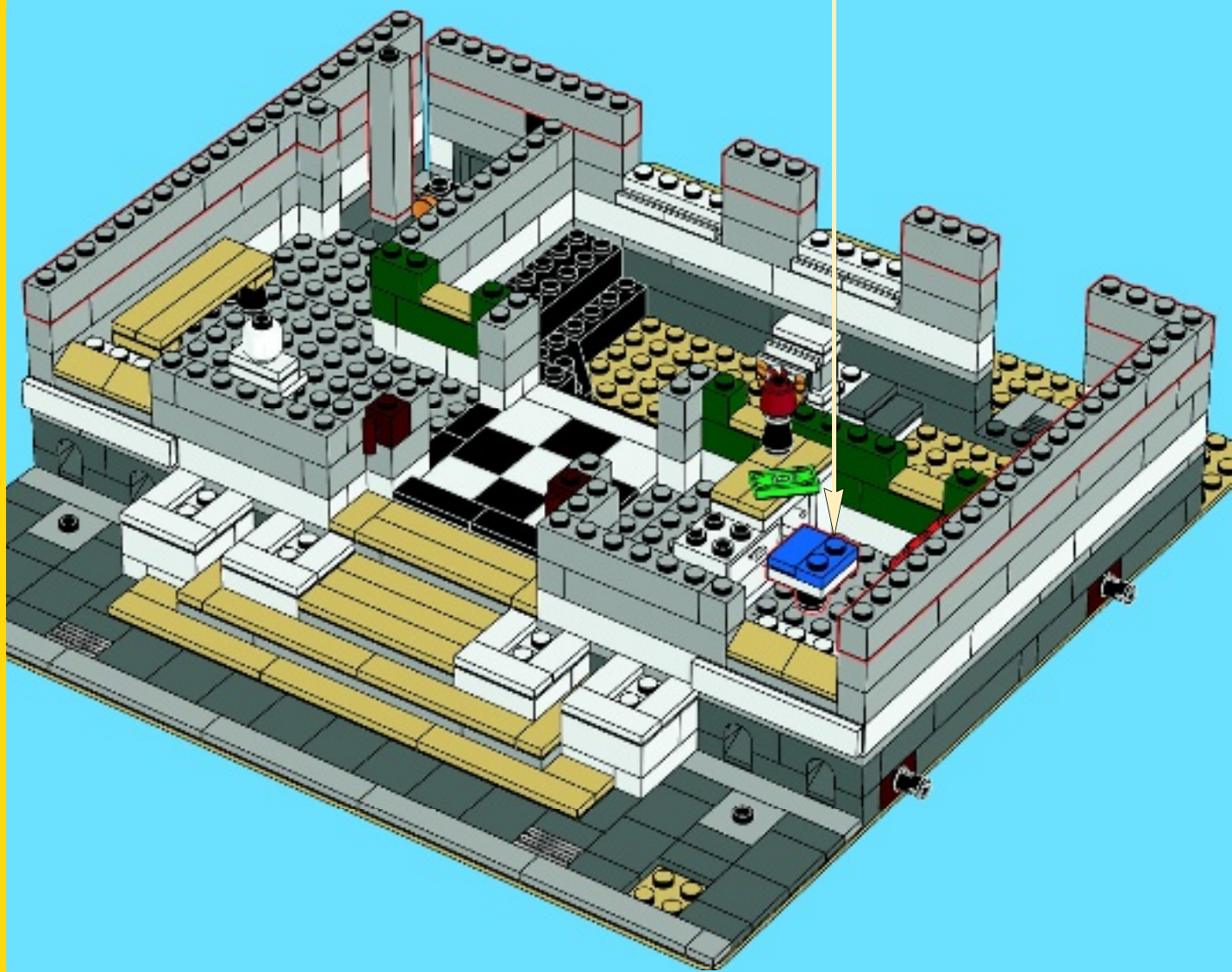
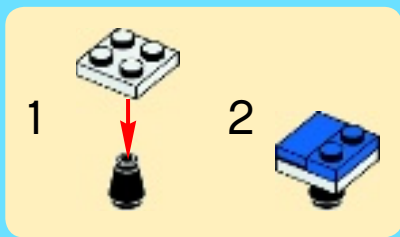

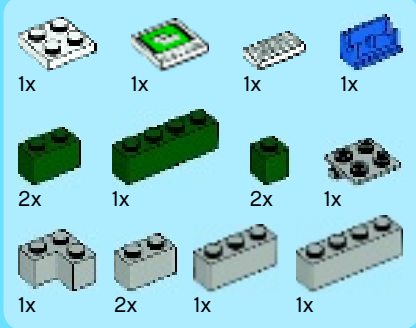

23

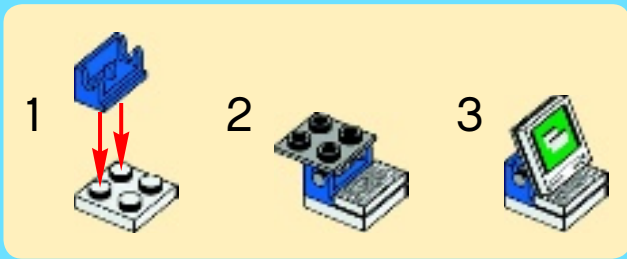
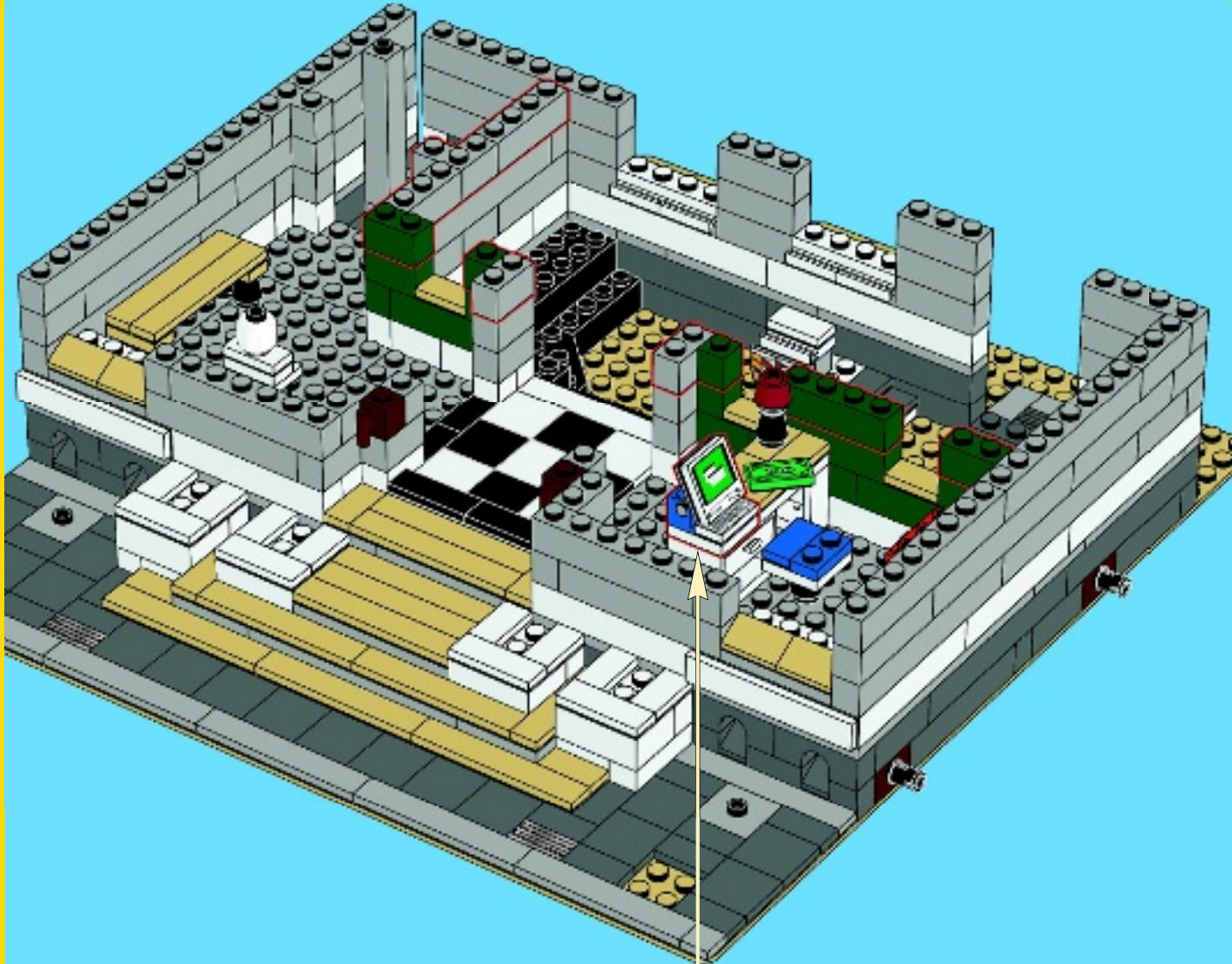

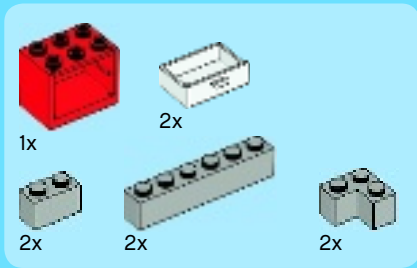

24



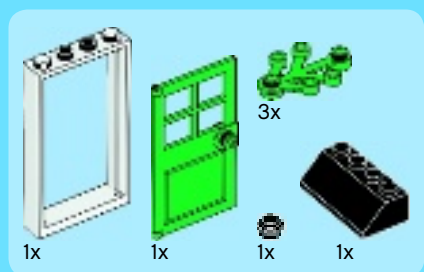

25

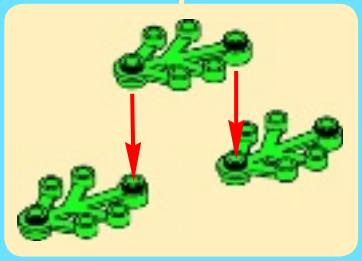
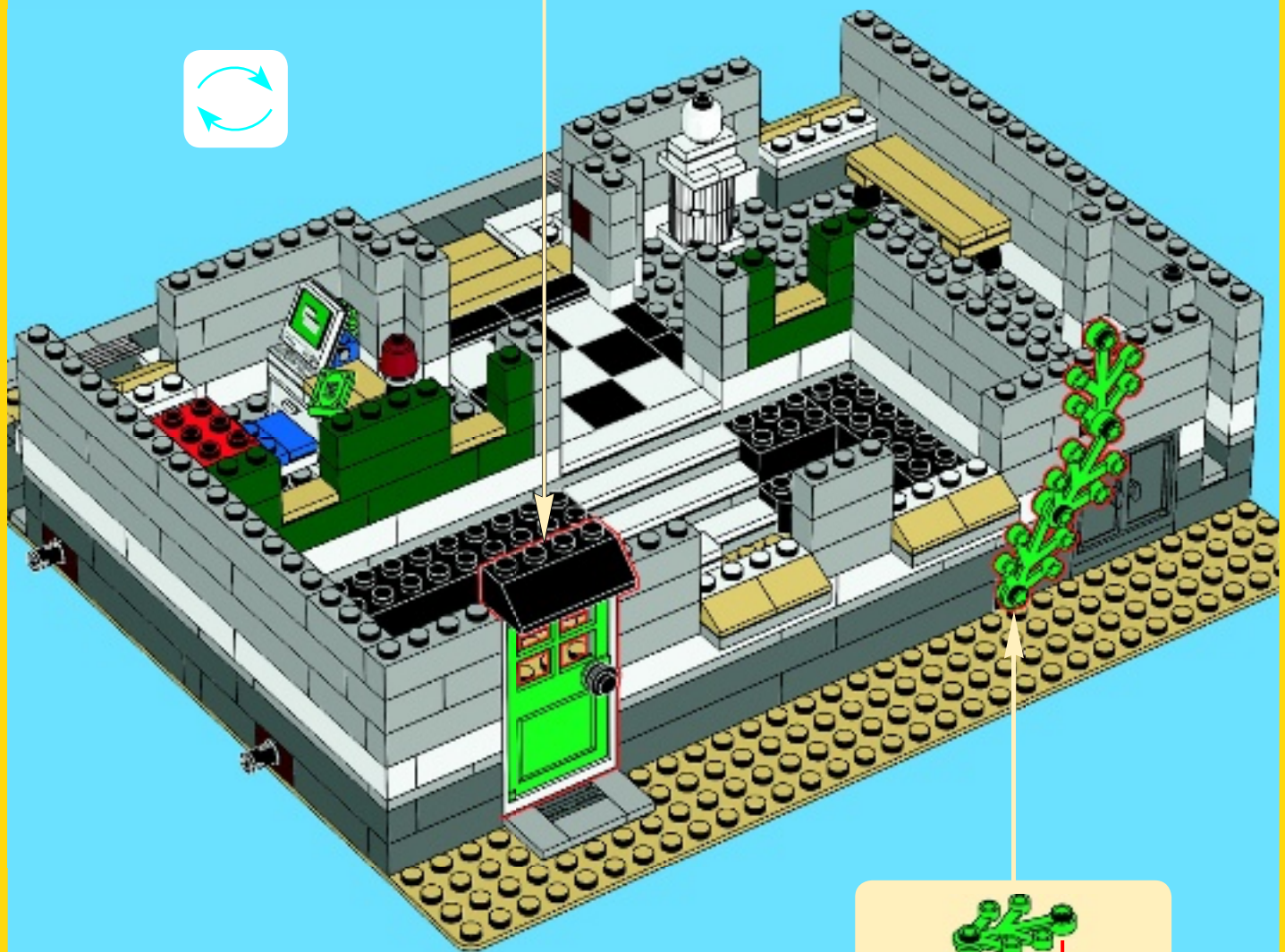
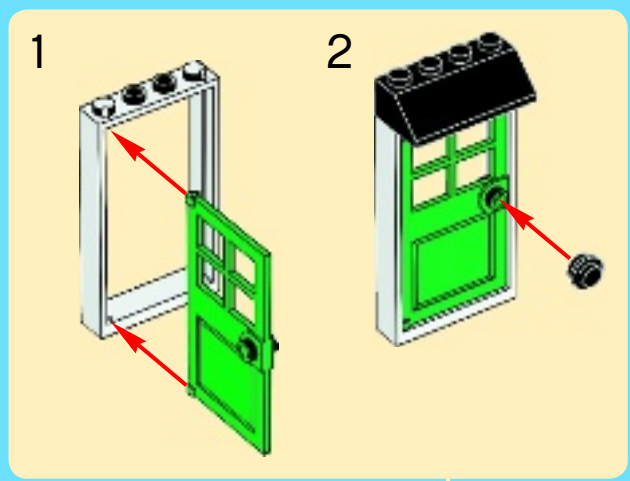

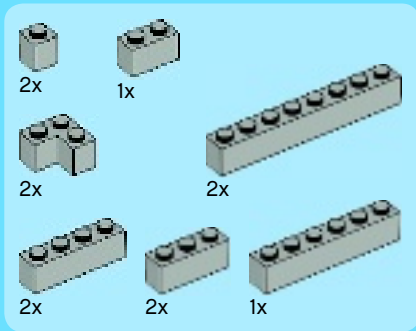

26

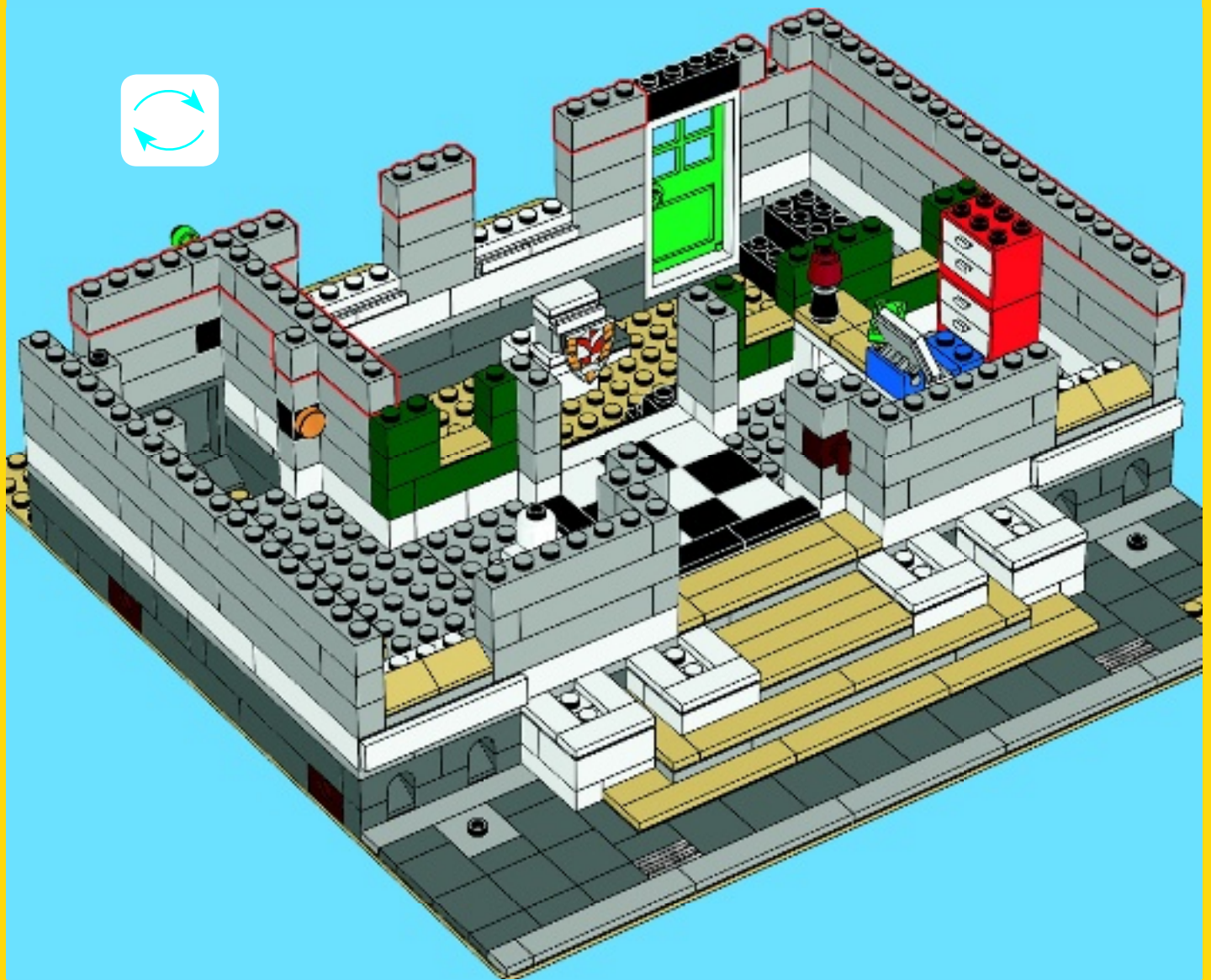

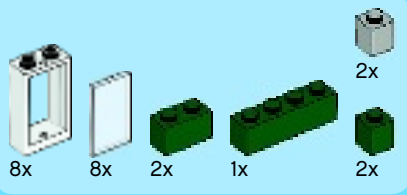

27

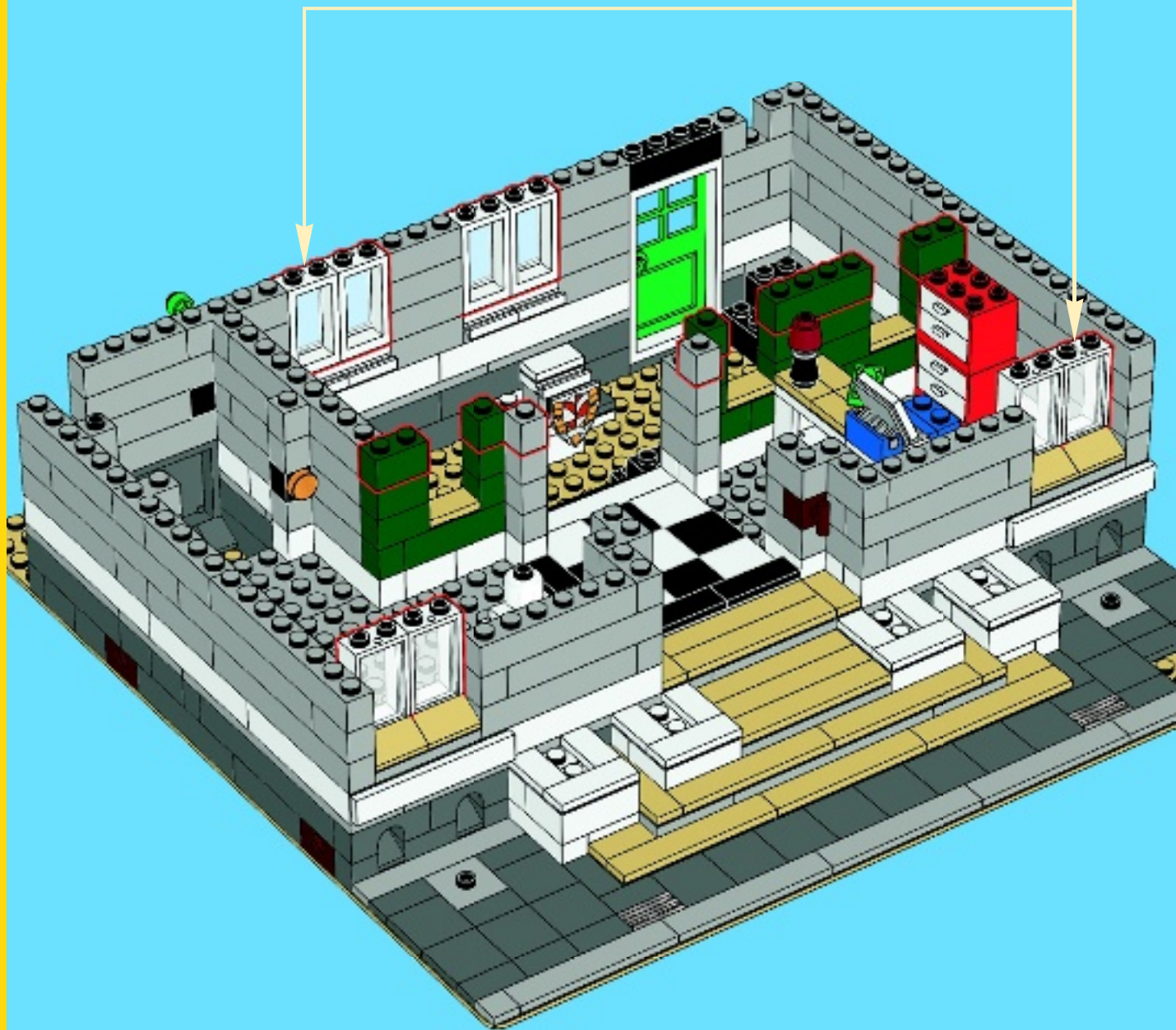
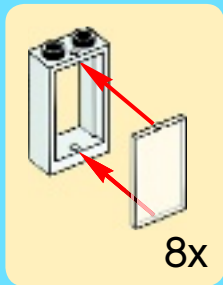

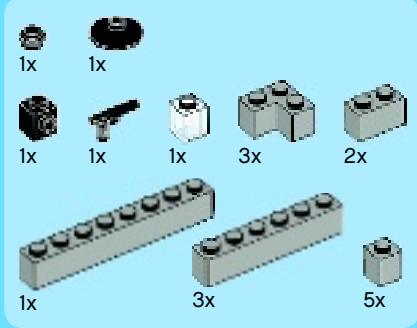

28

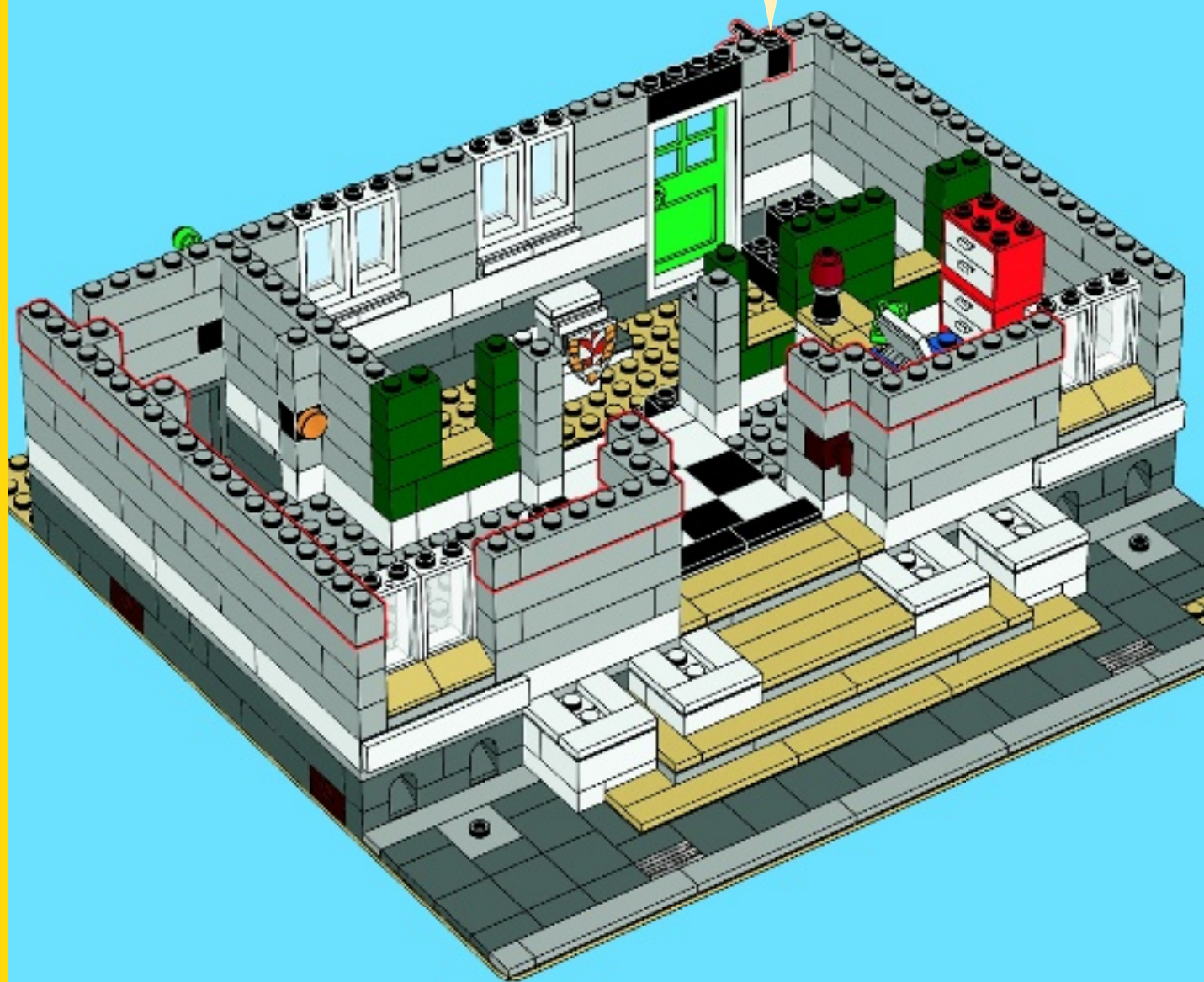
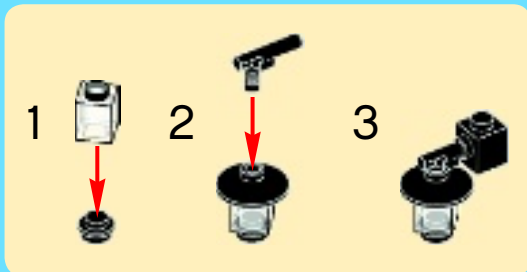

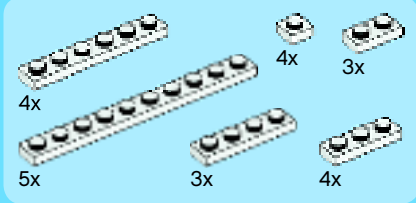

29

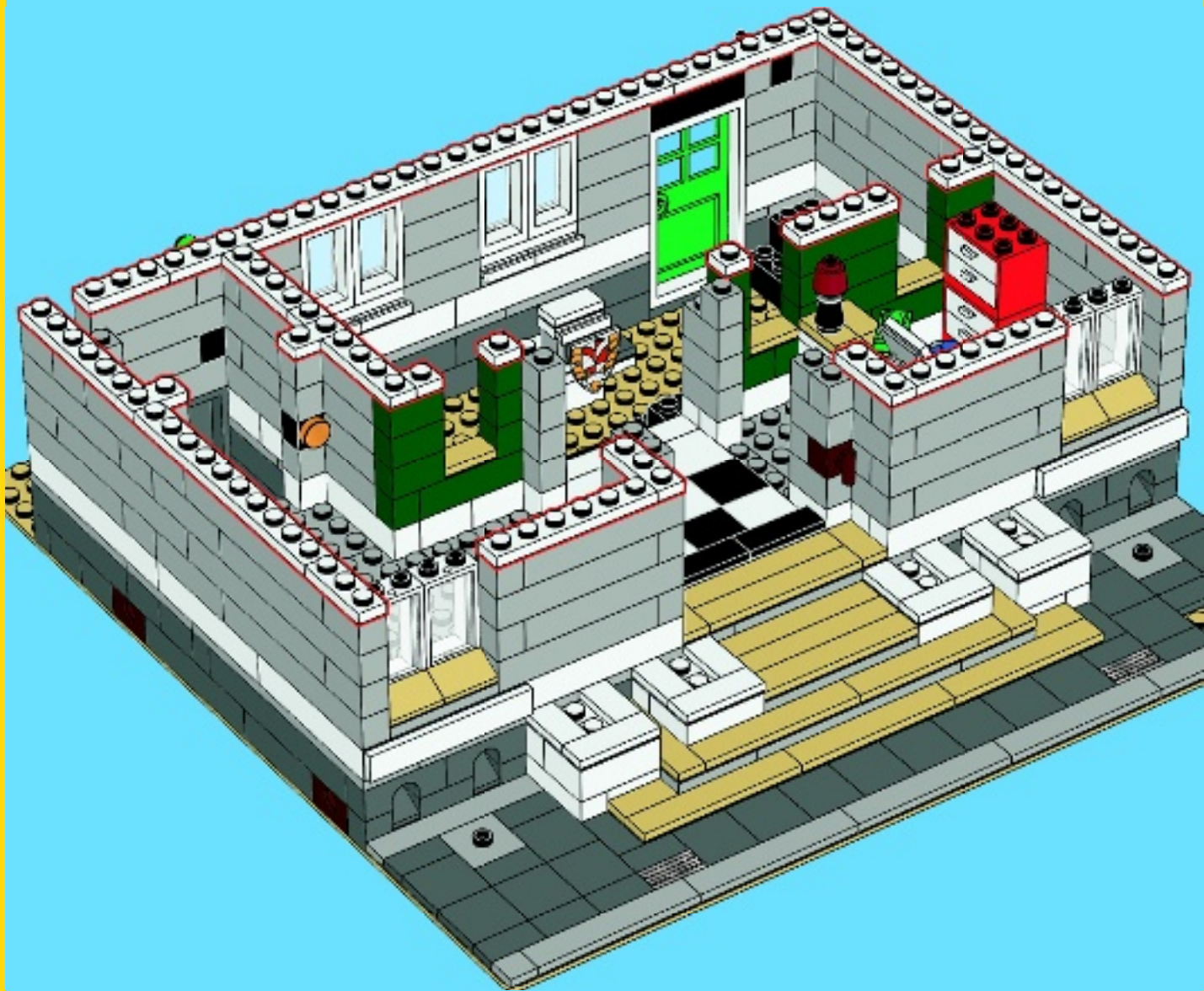

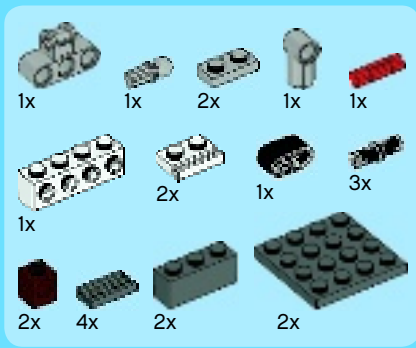

30

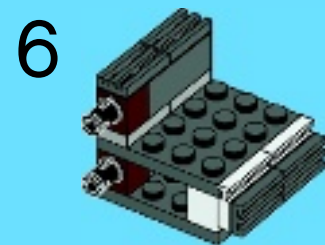
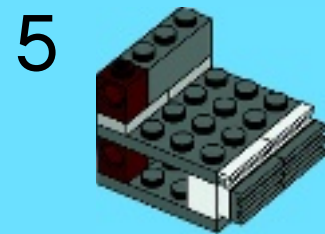
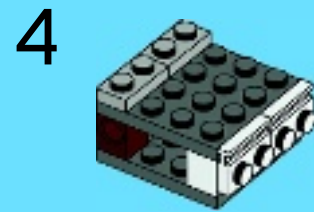
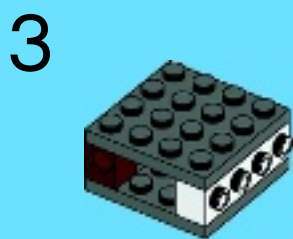
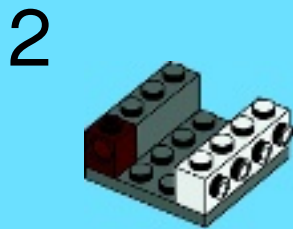
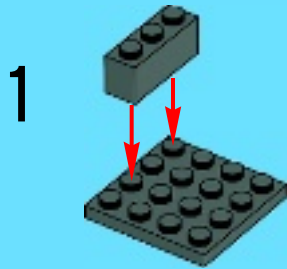

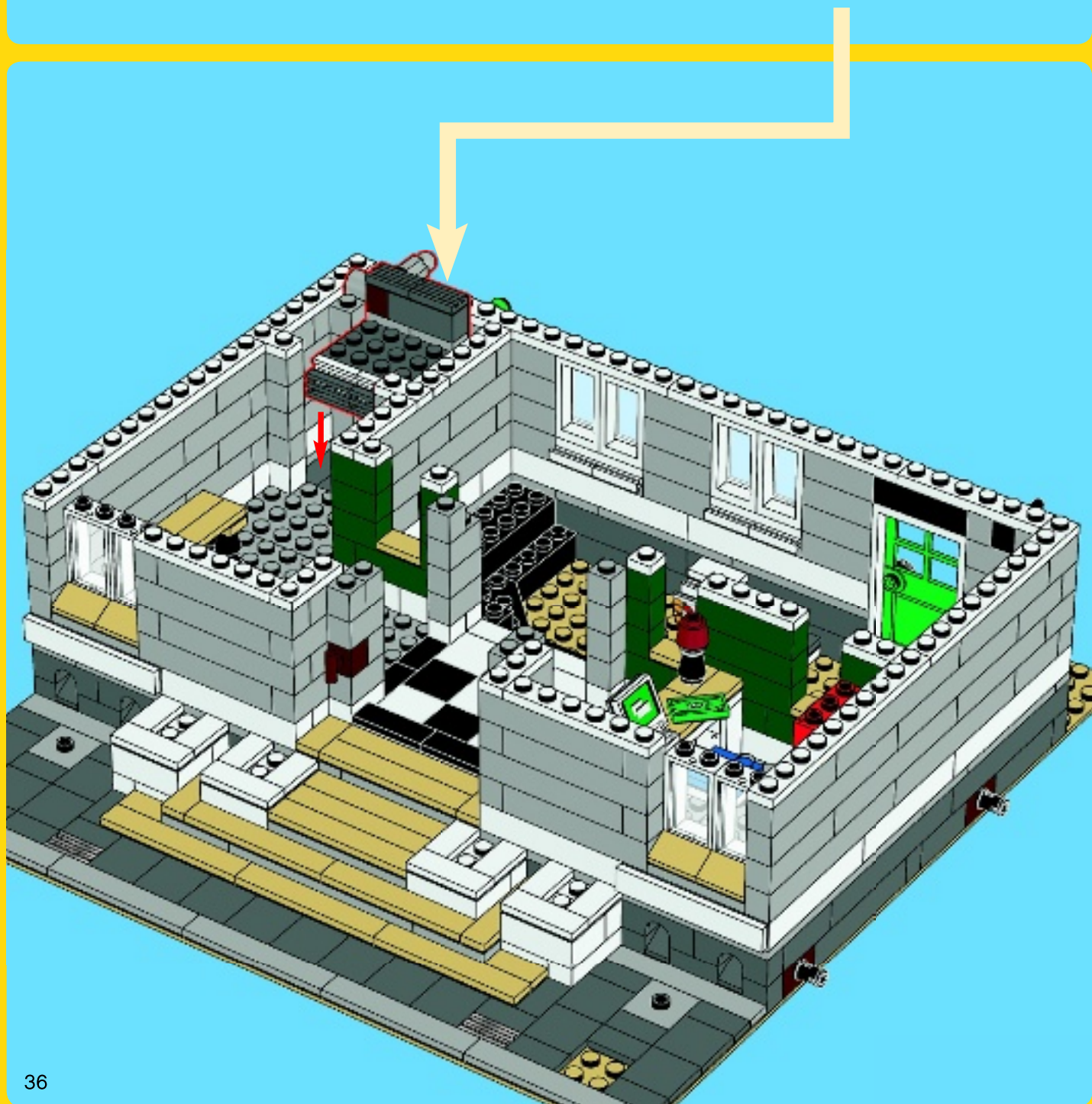
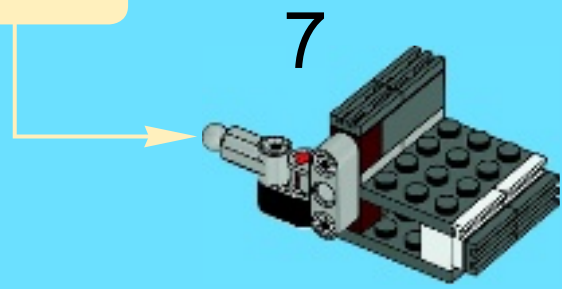
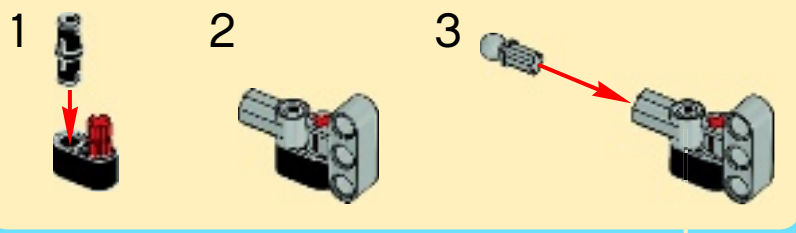

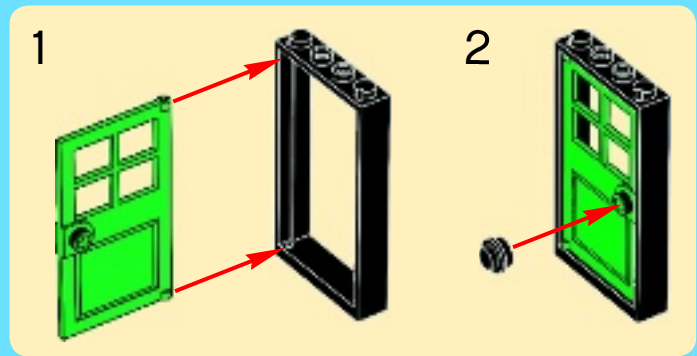
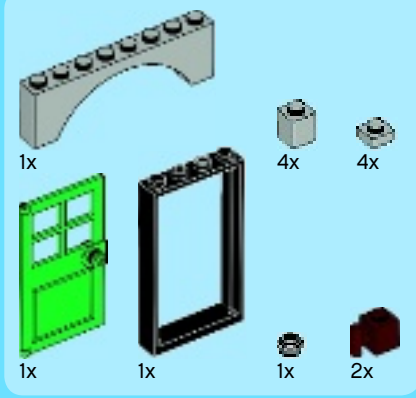

31

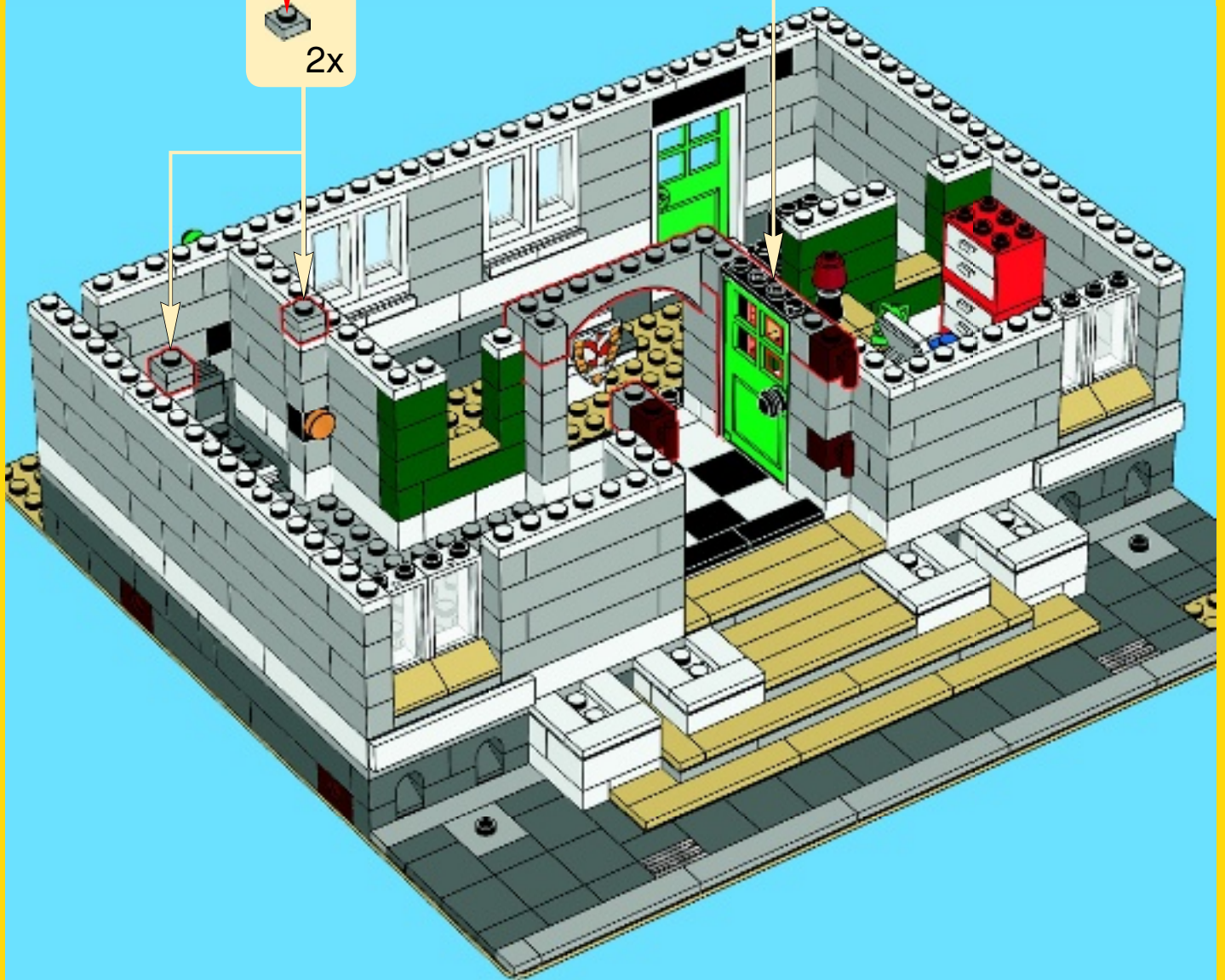
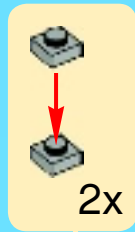

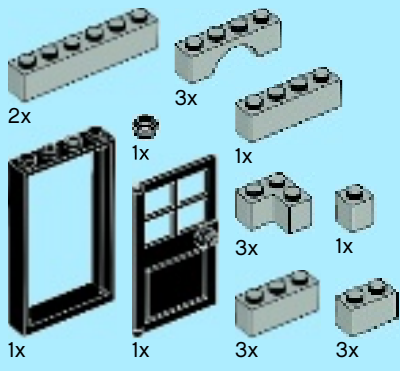

32

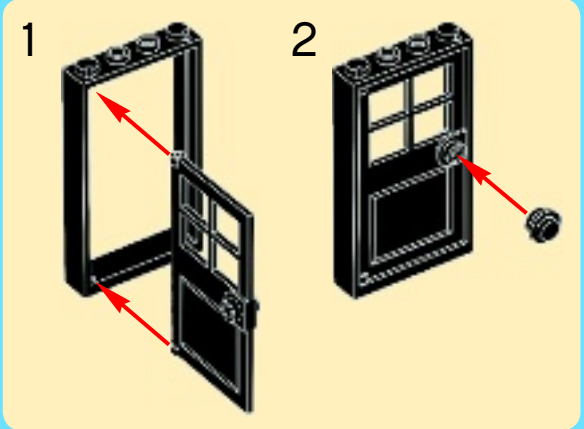
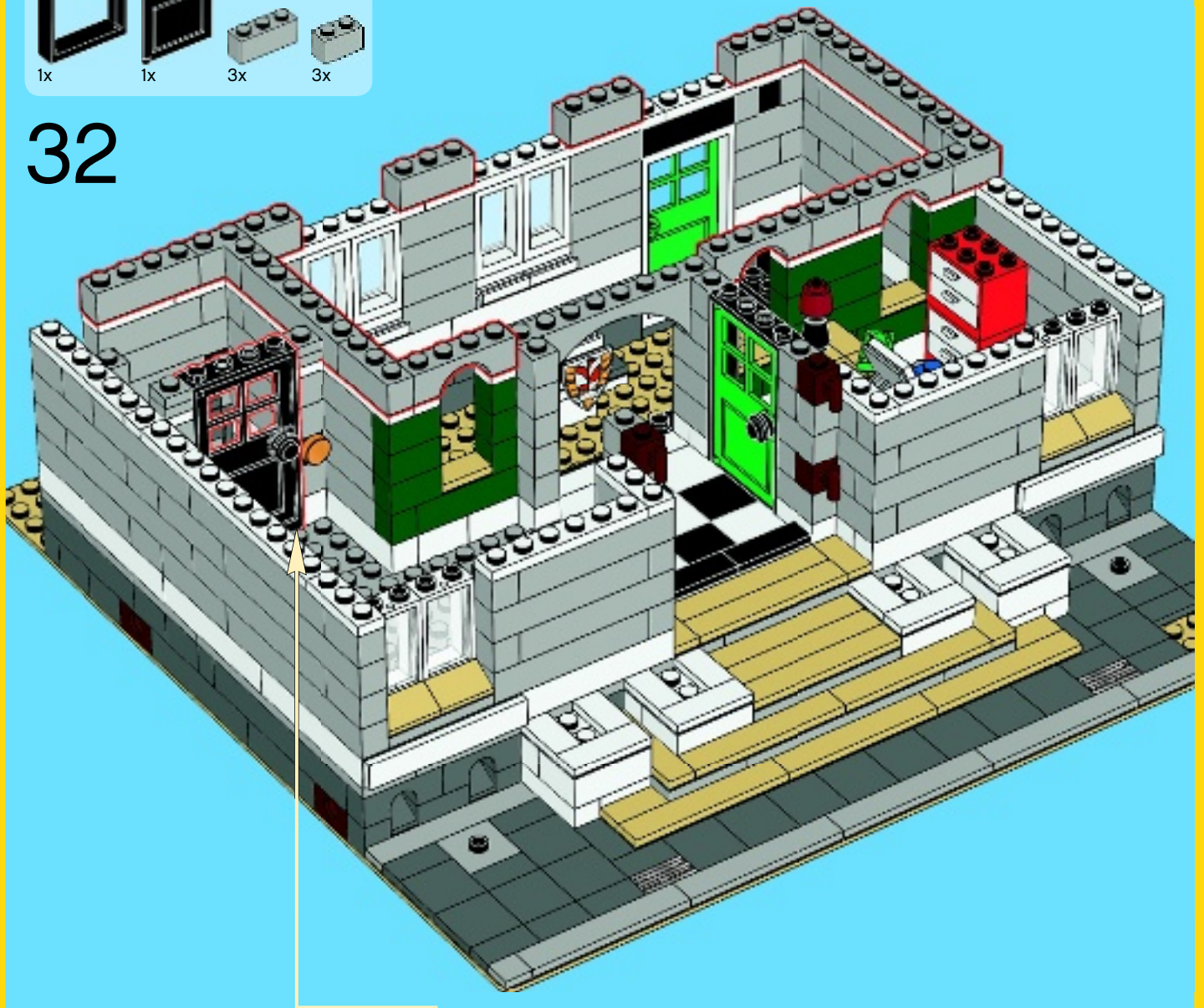

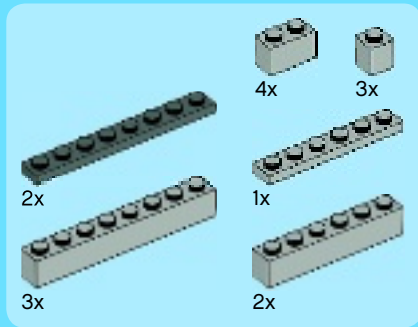

33

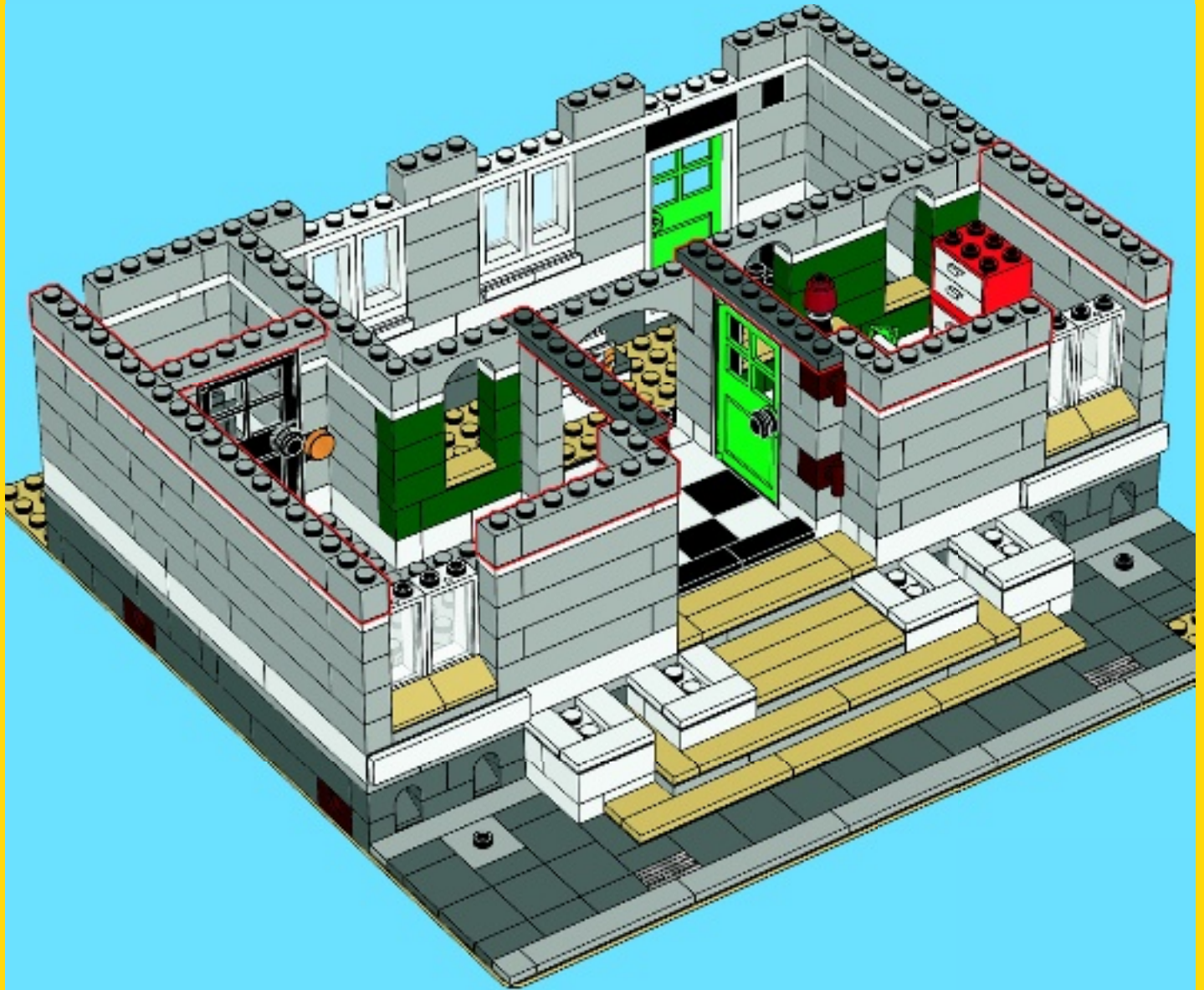

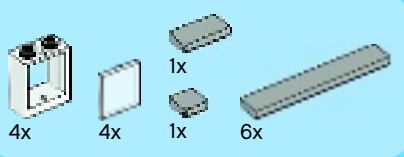

34

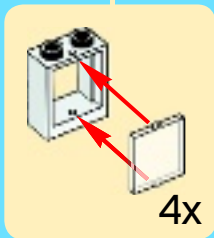
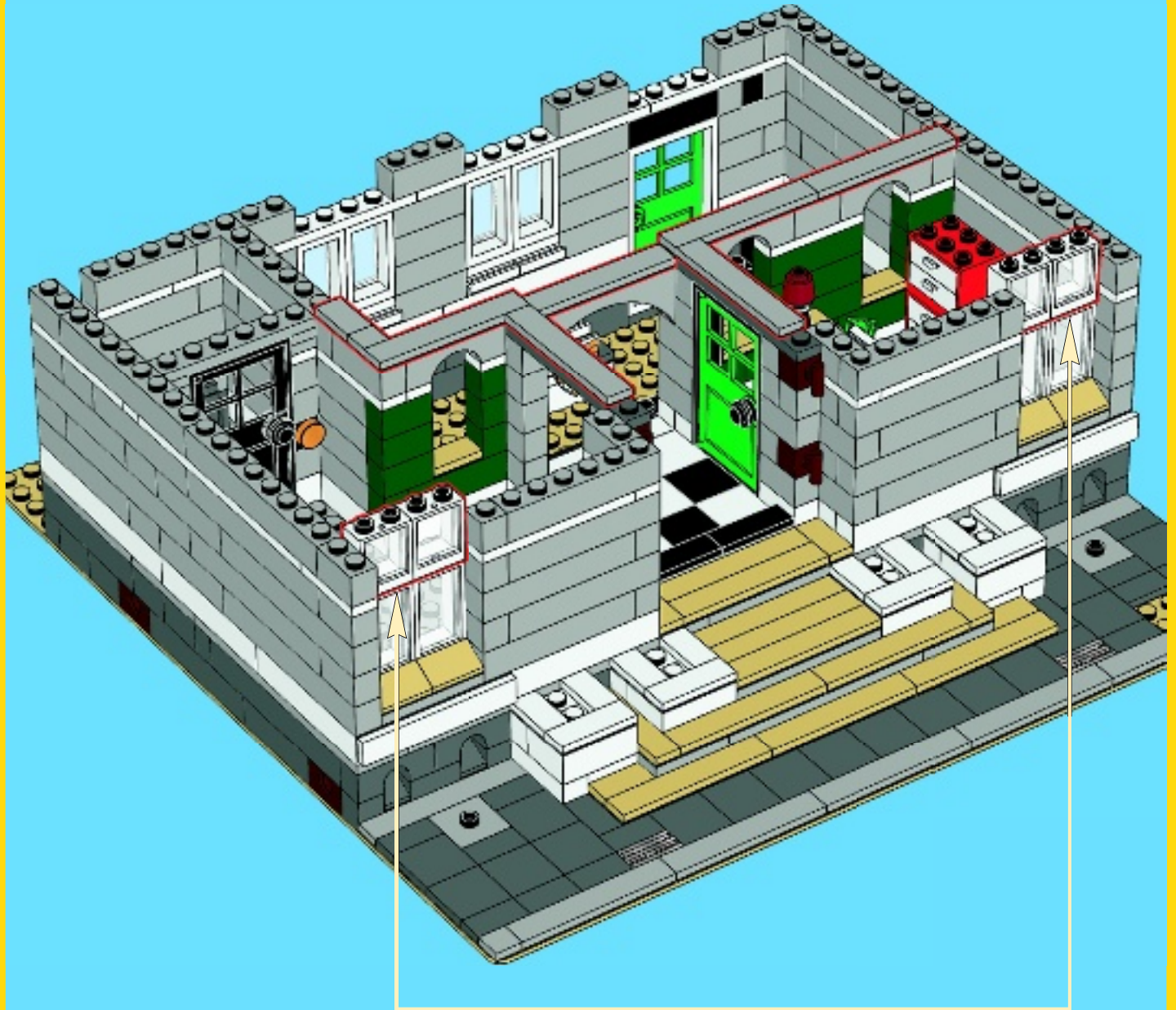

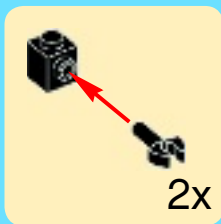
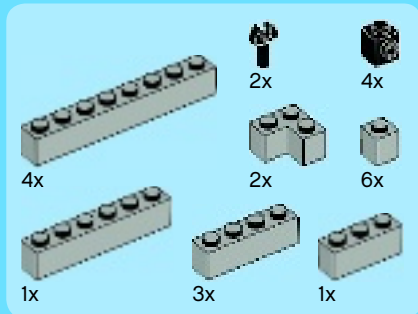

35

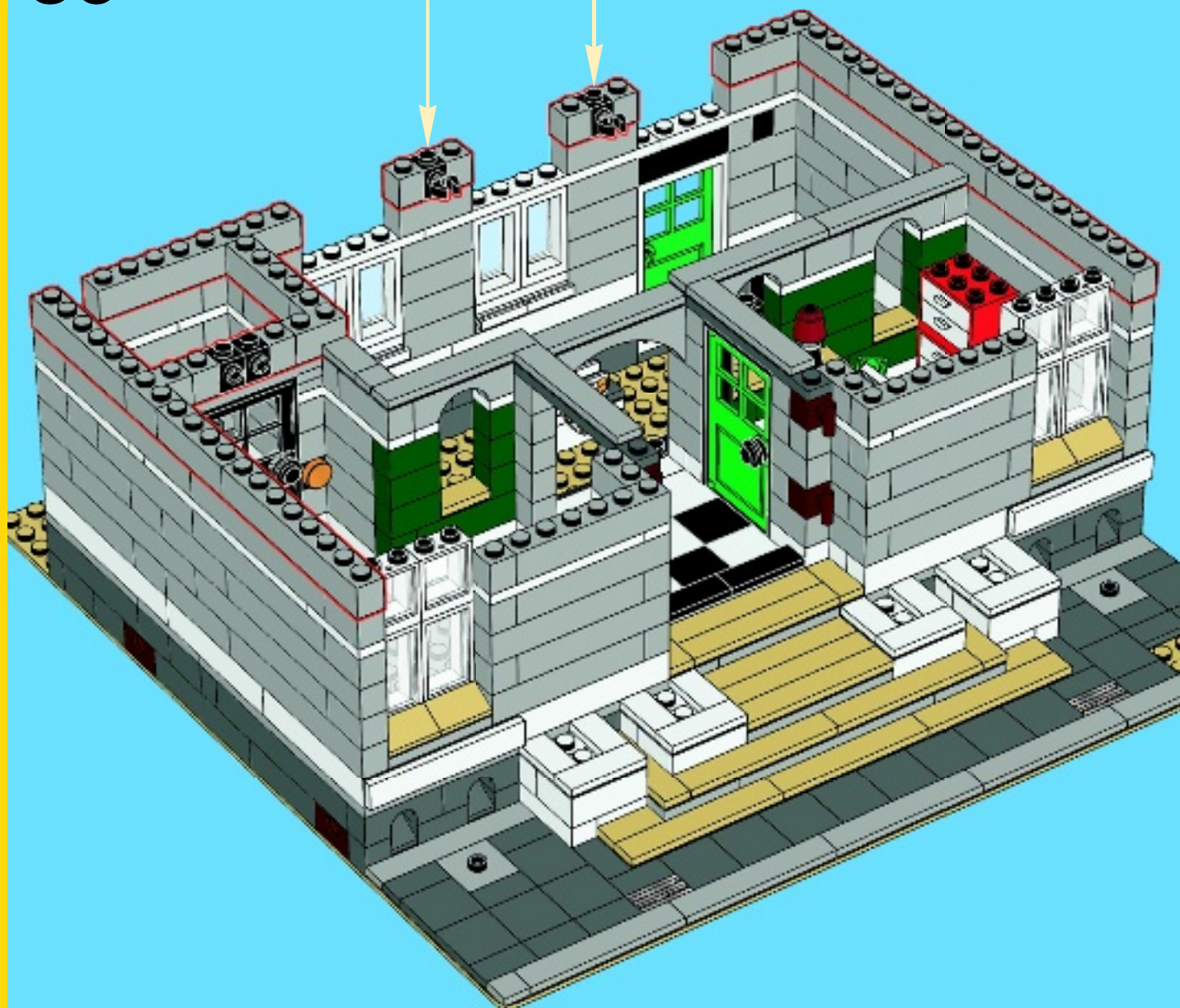

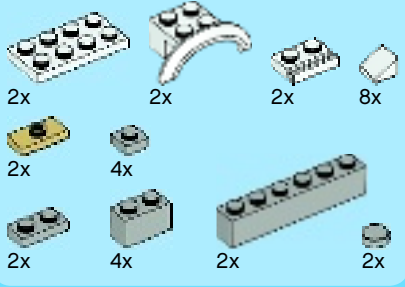

36

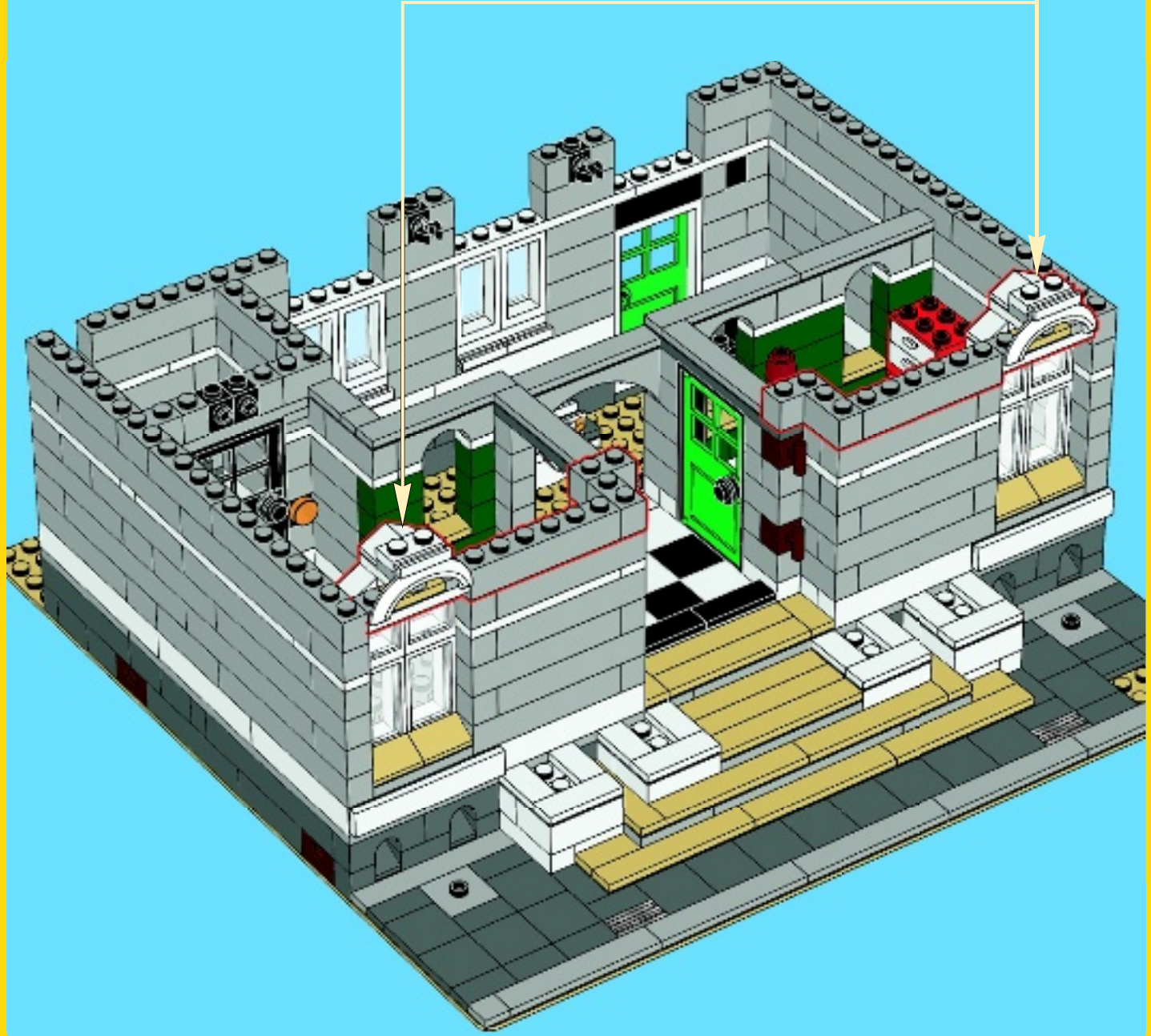
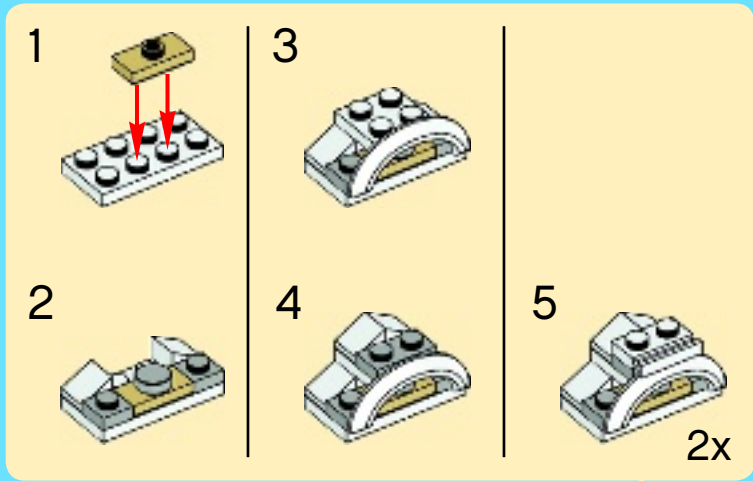

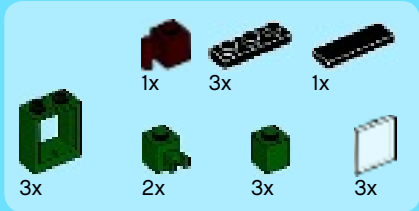
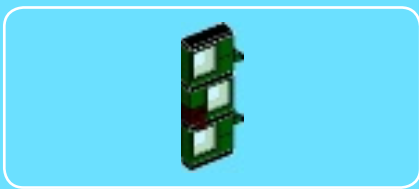

37

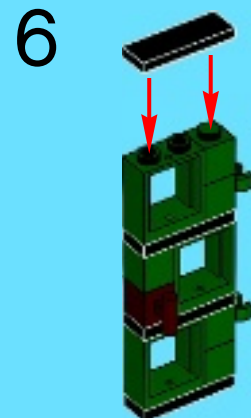
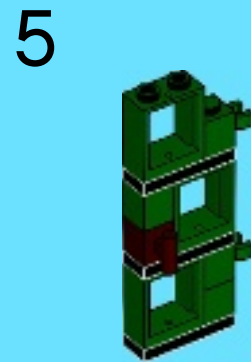
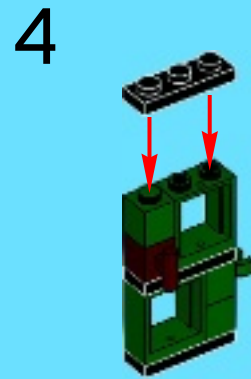
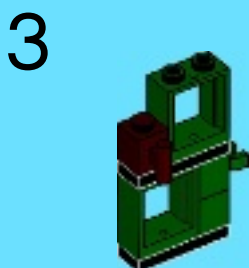
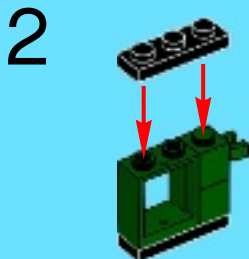
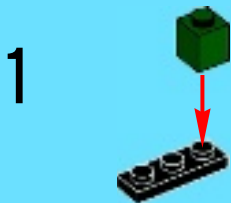

7

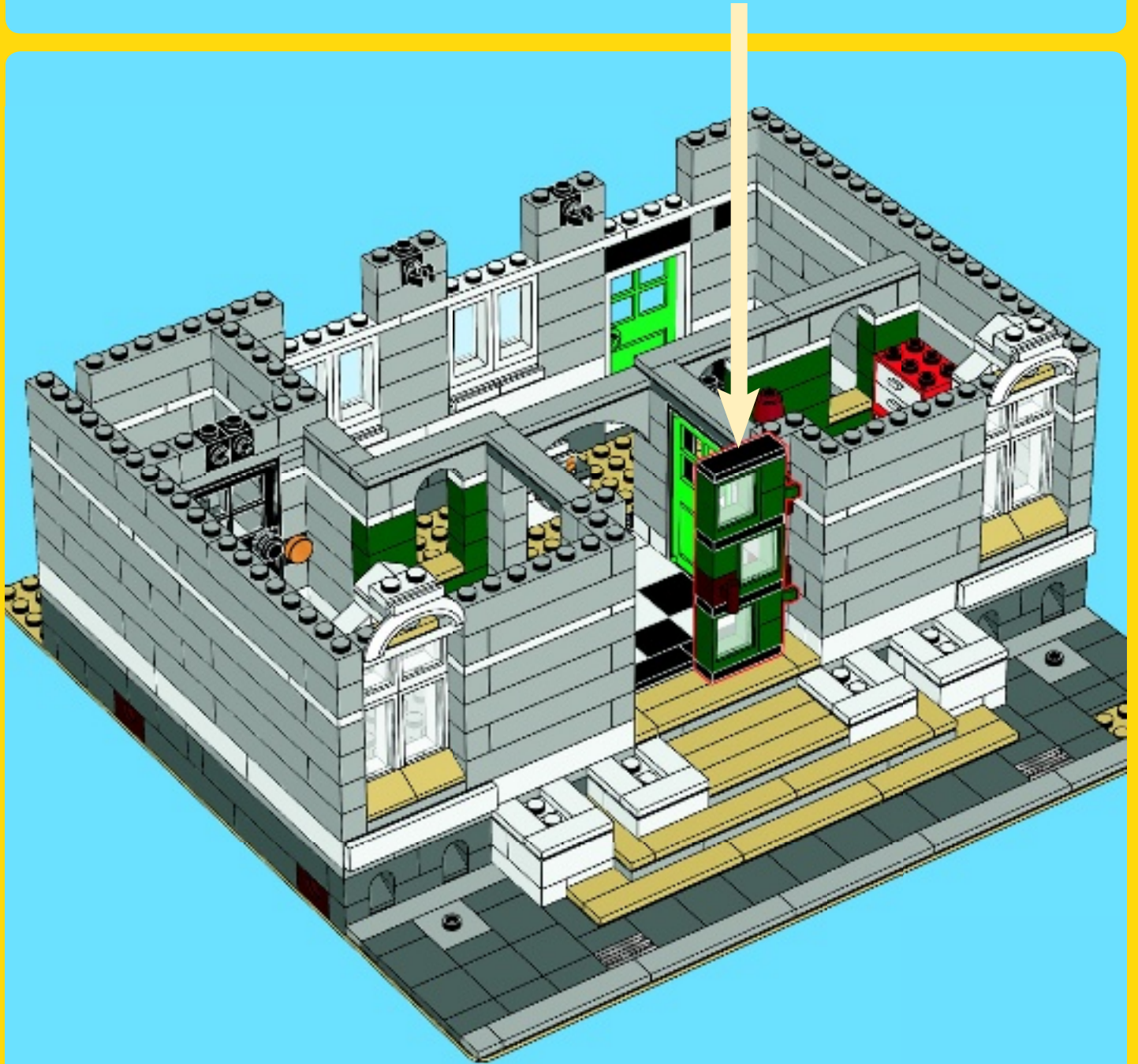
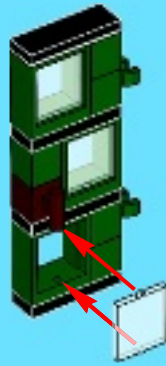

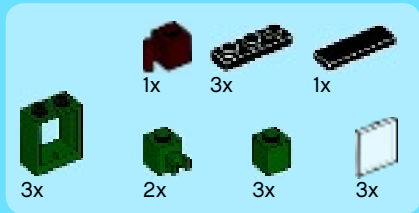
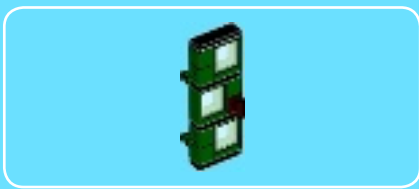

38

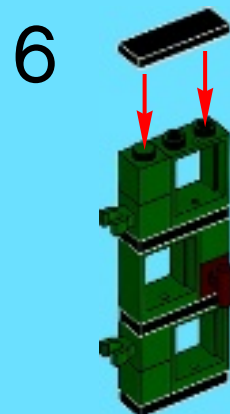
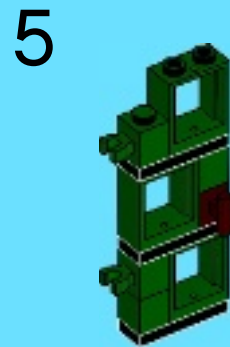
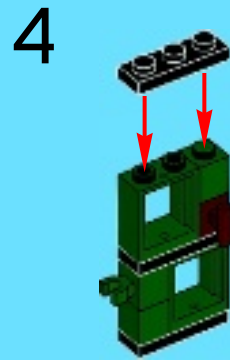
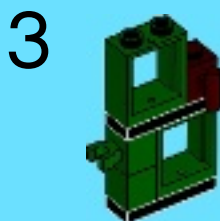
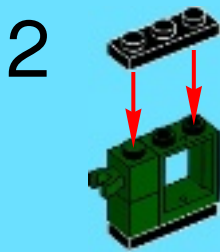
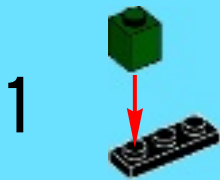

7

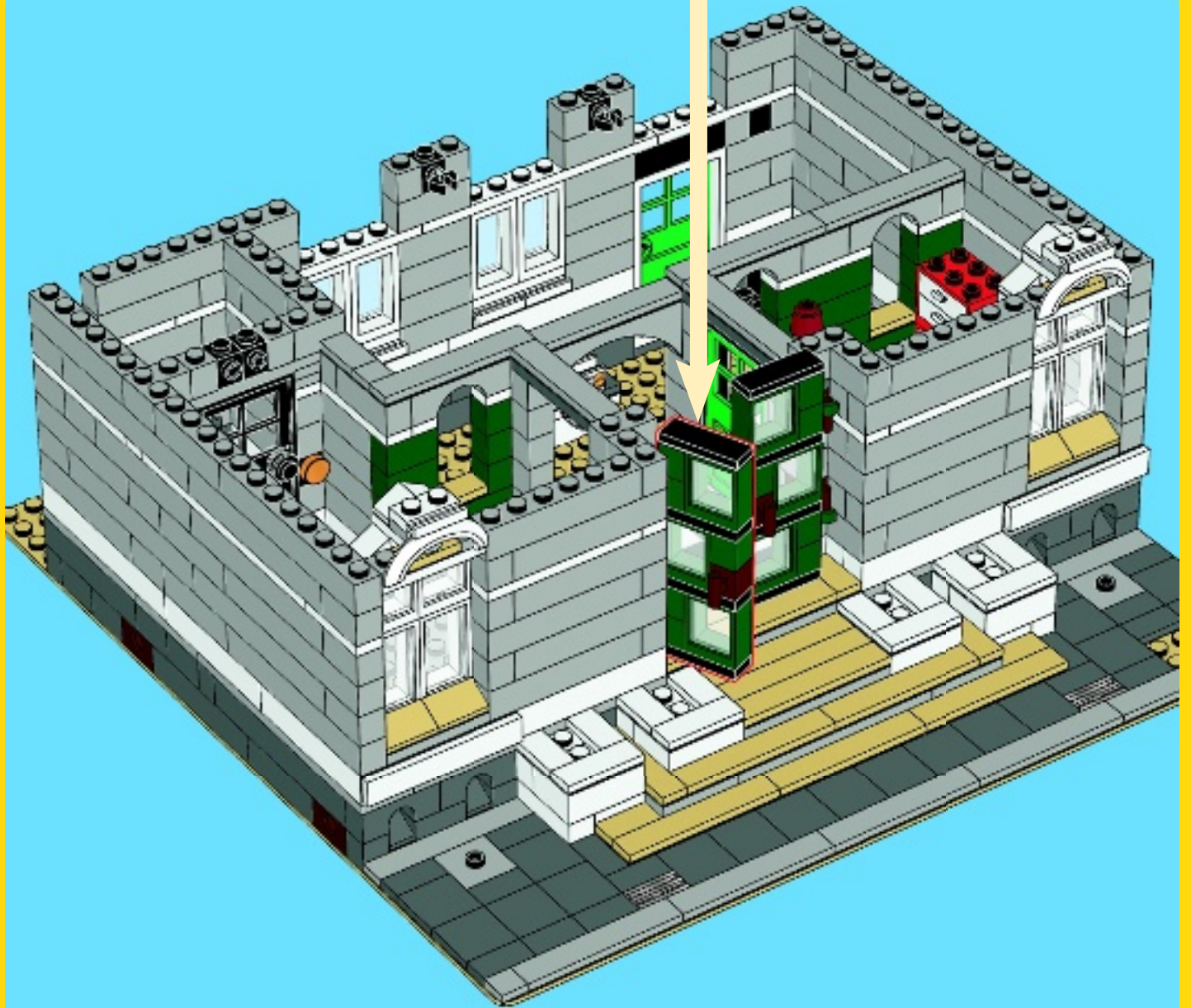
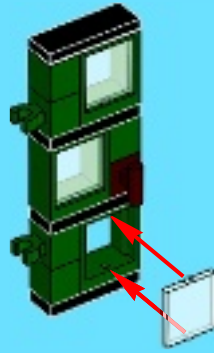

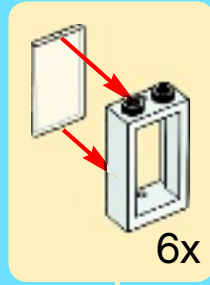
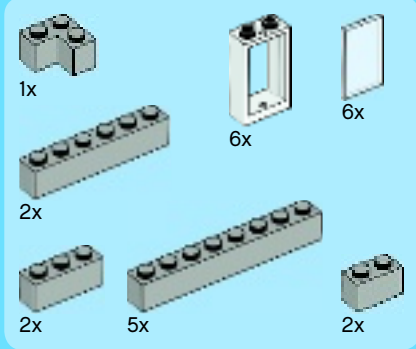

39

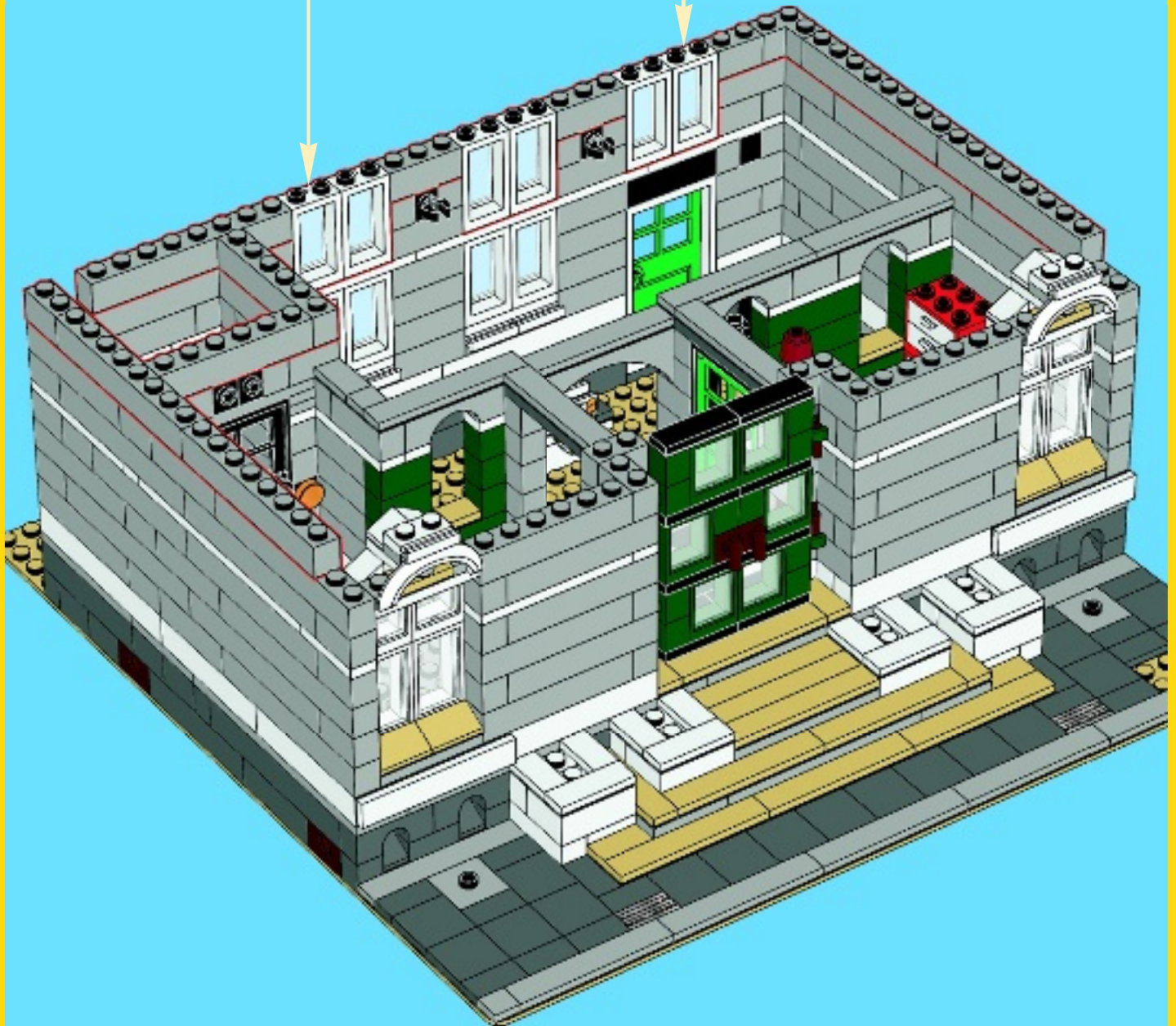

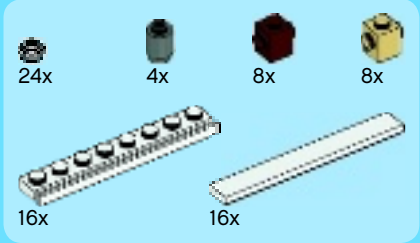

40

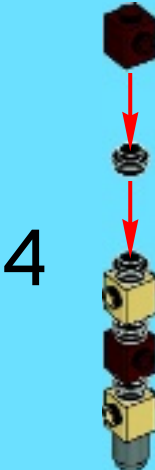
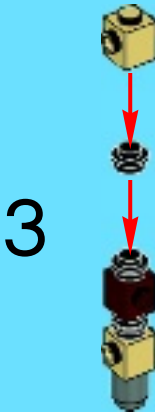
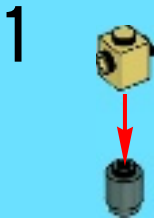

5

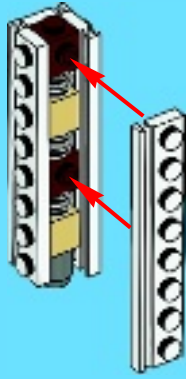

6



4x

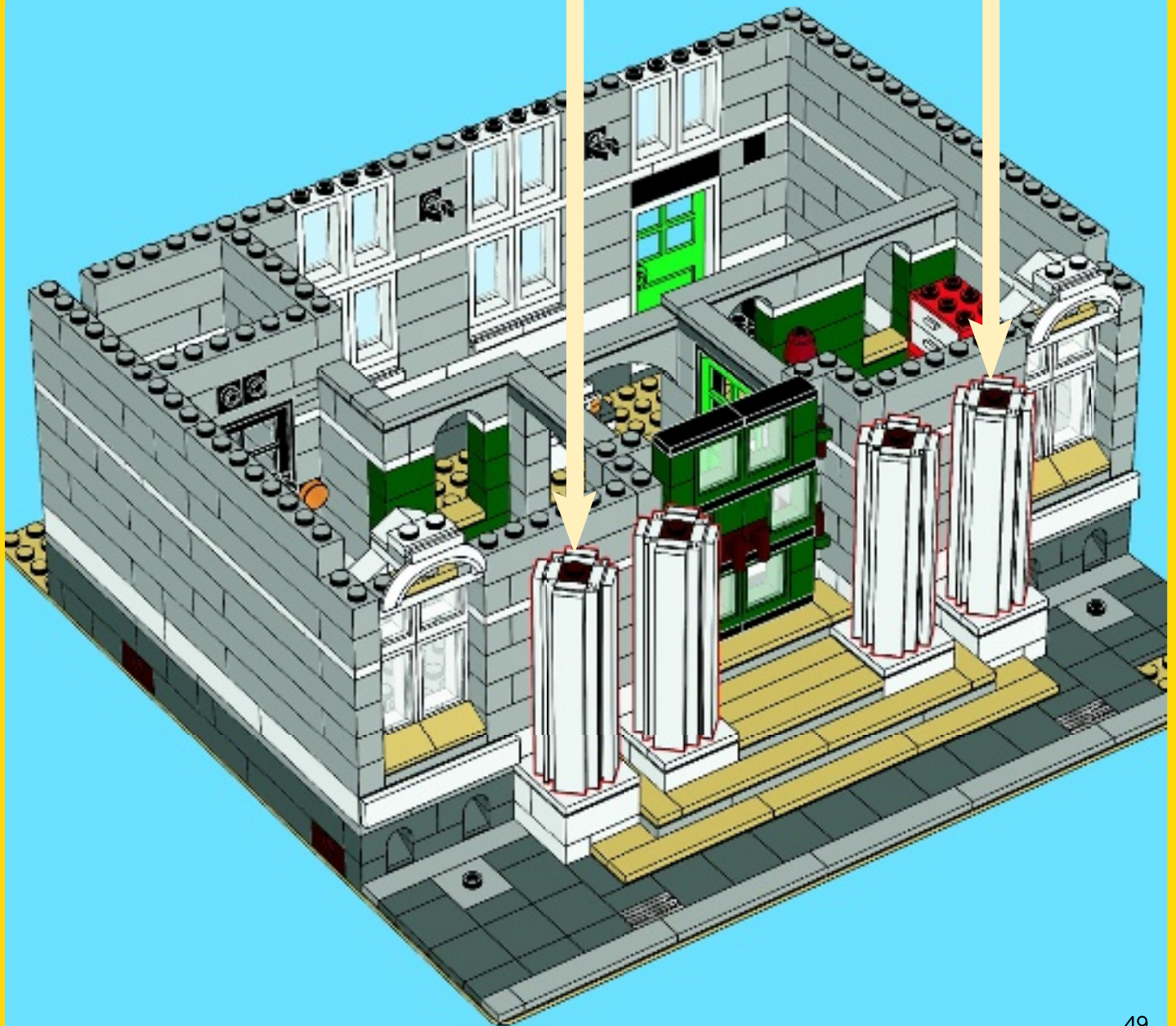



41

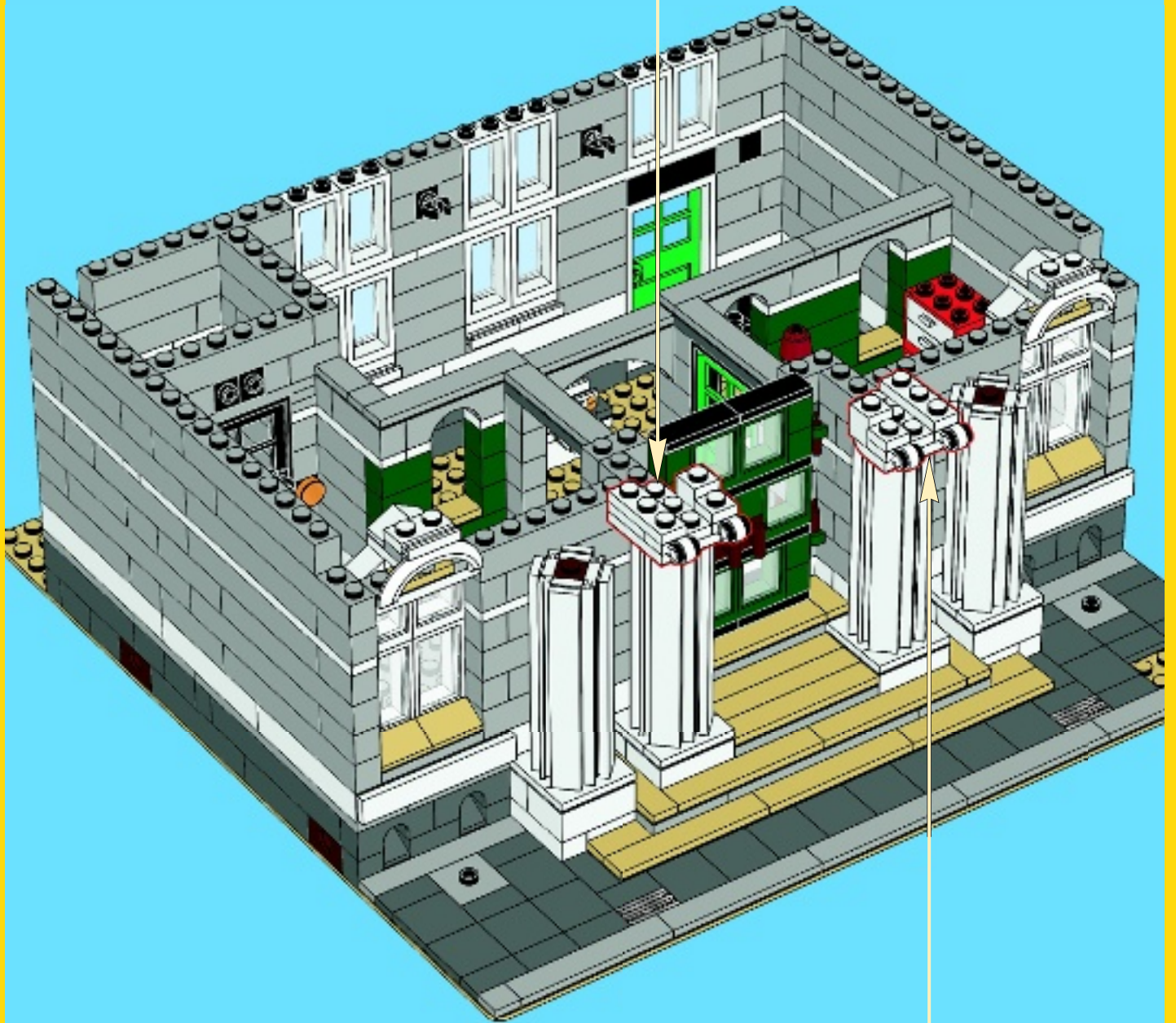



42

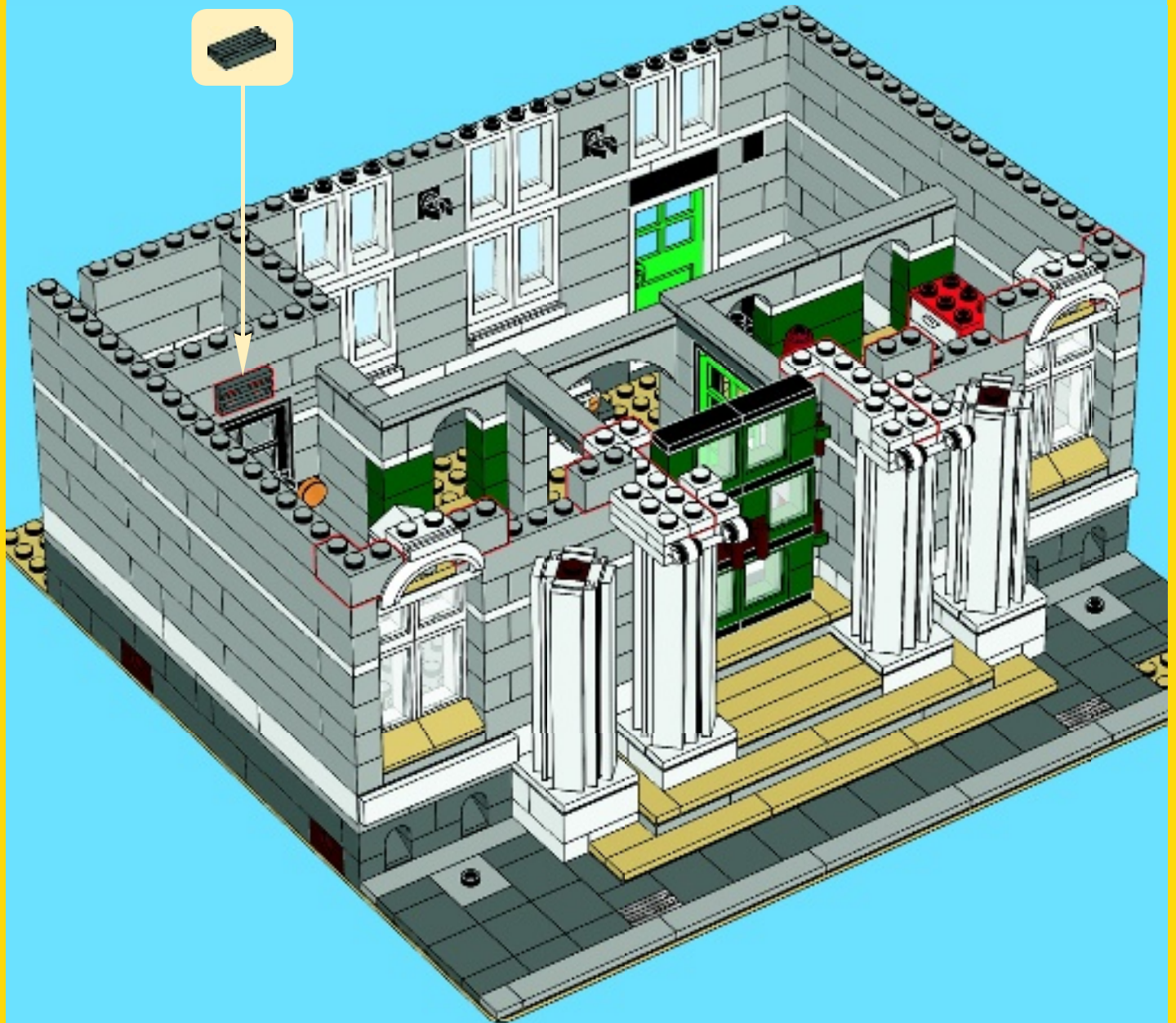

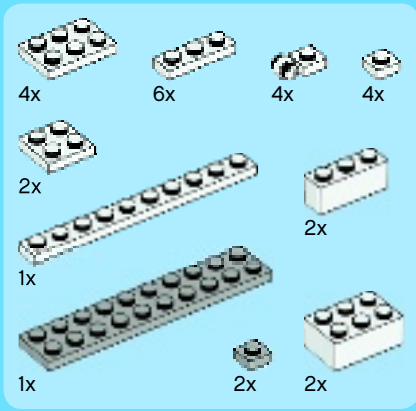

43

1

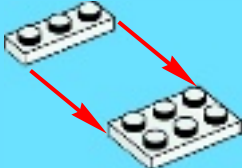

2



3

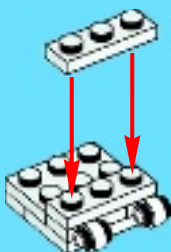

4

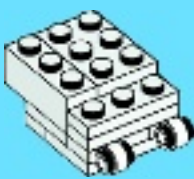

2x

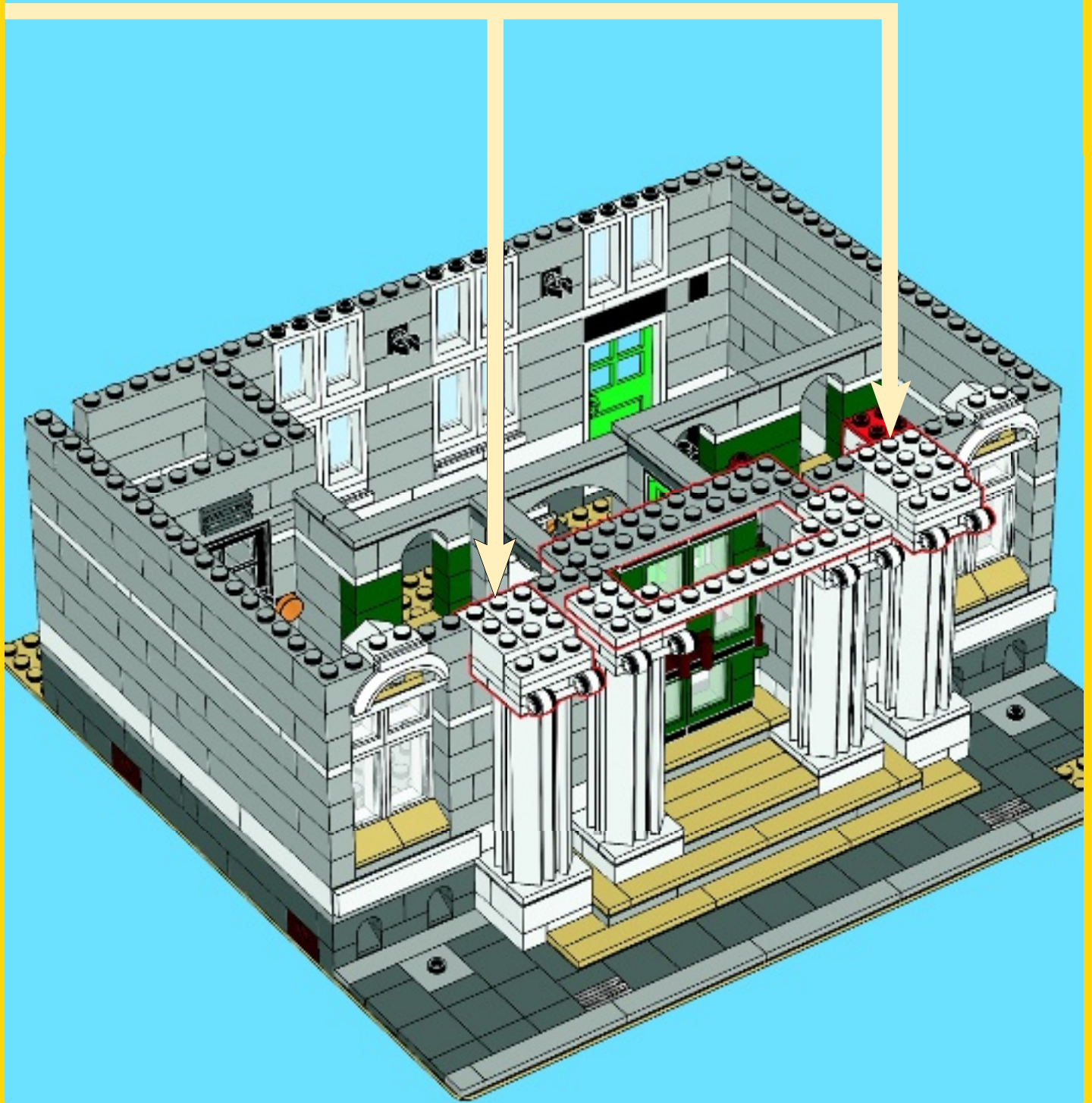

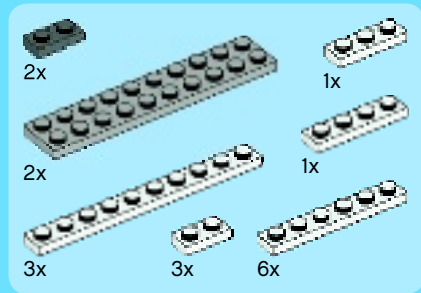

44

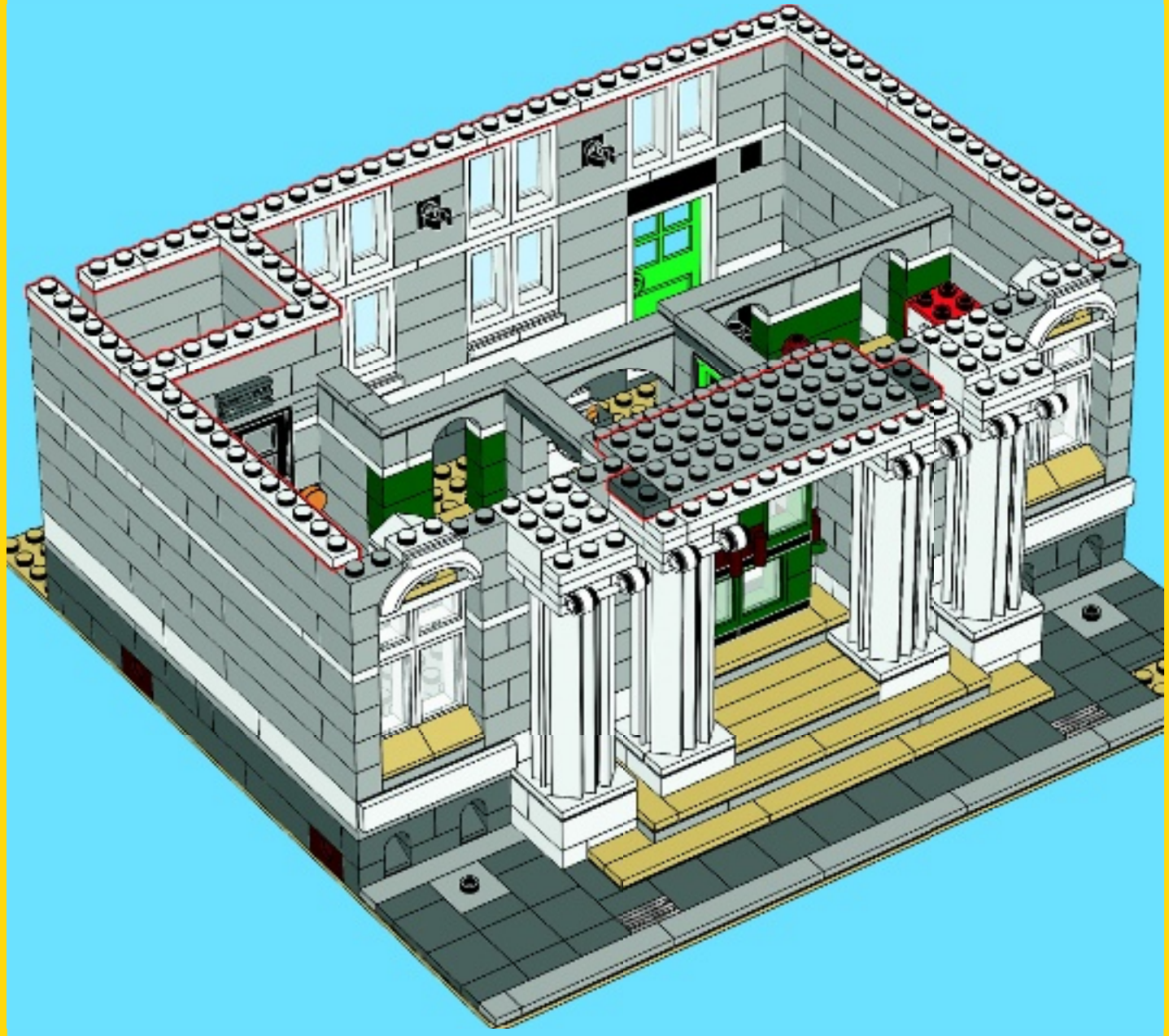

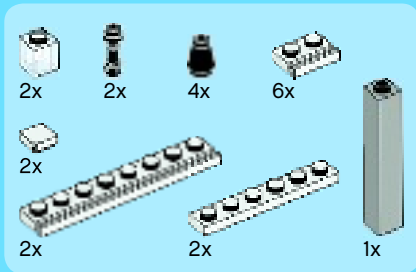

45

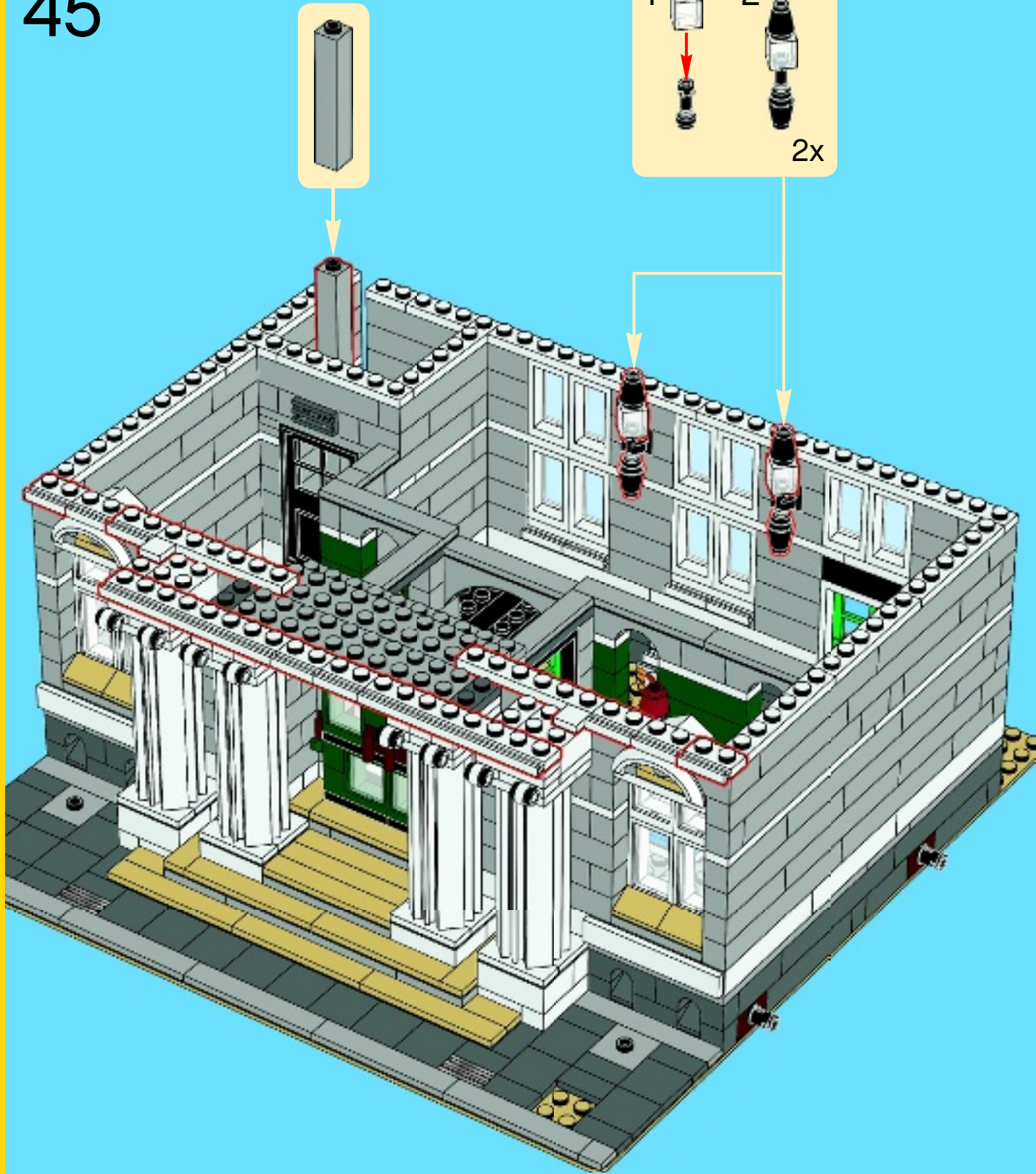
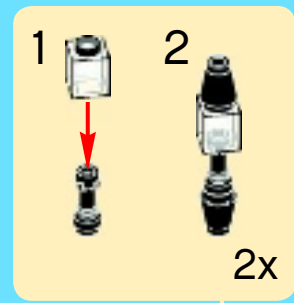

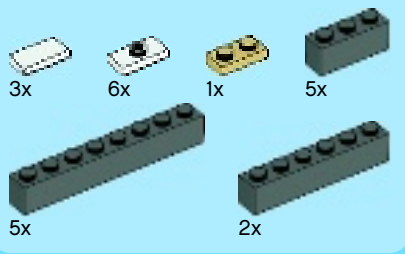

46

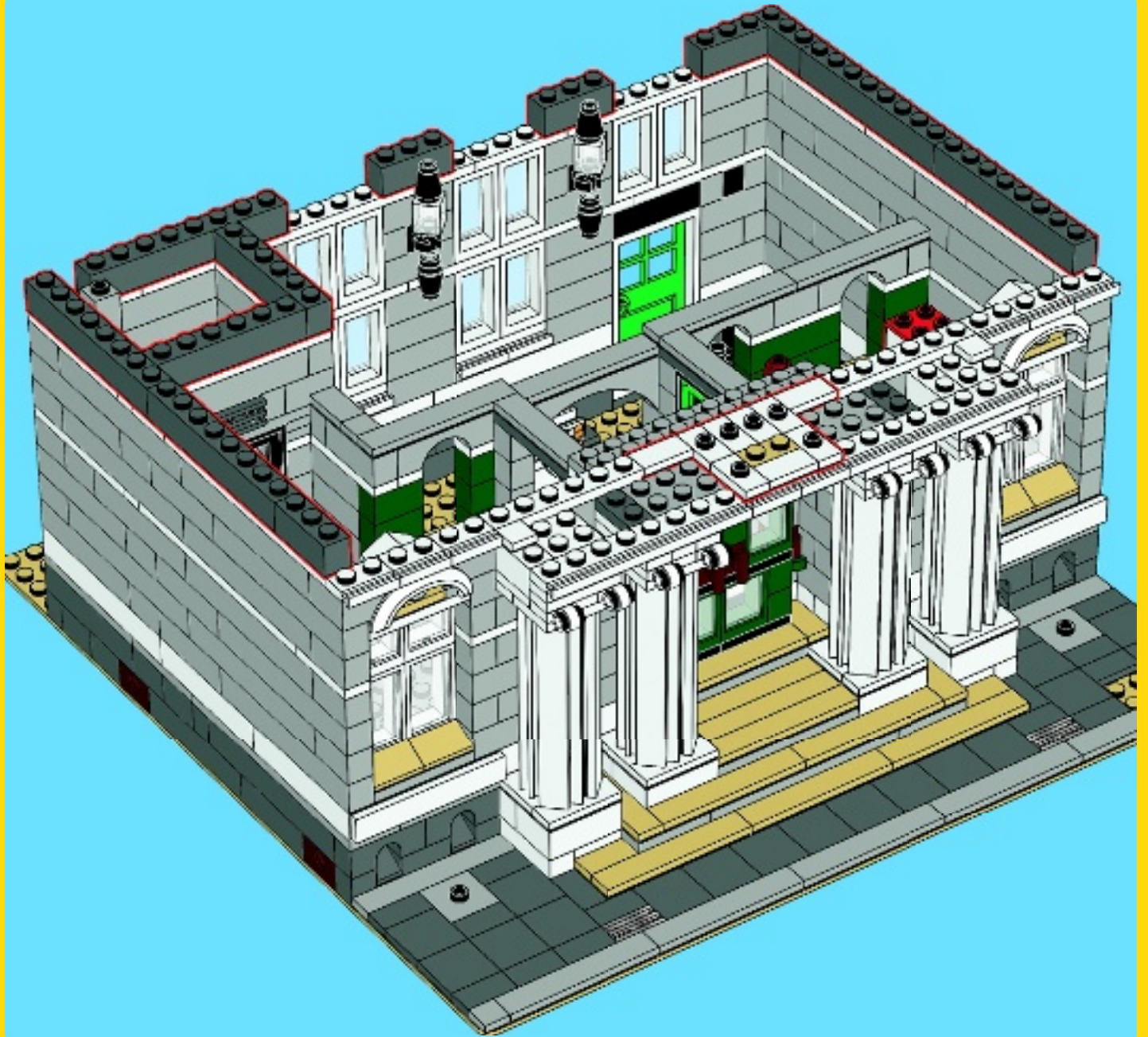

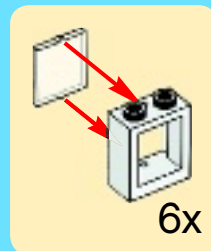
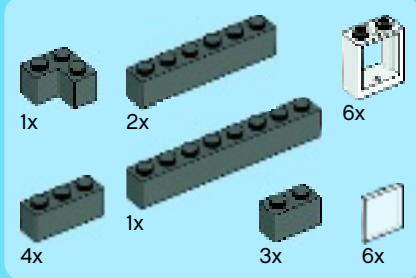

47

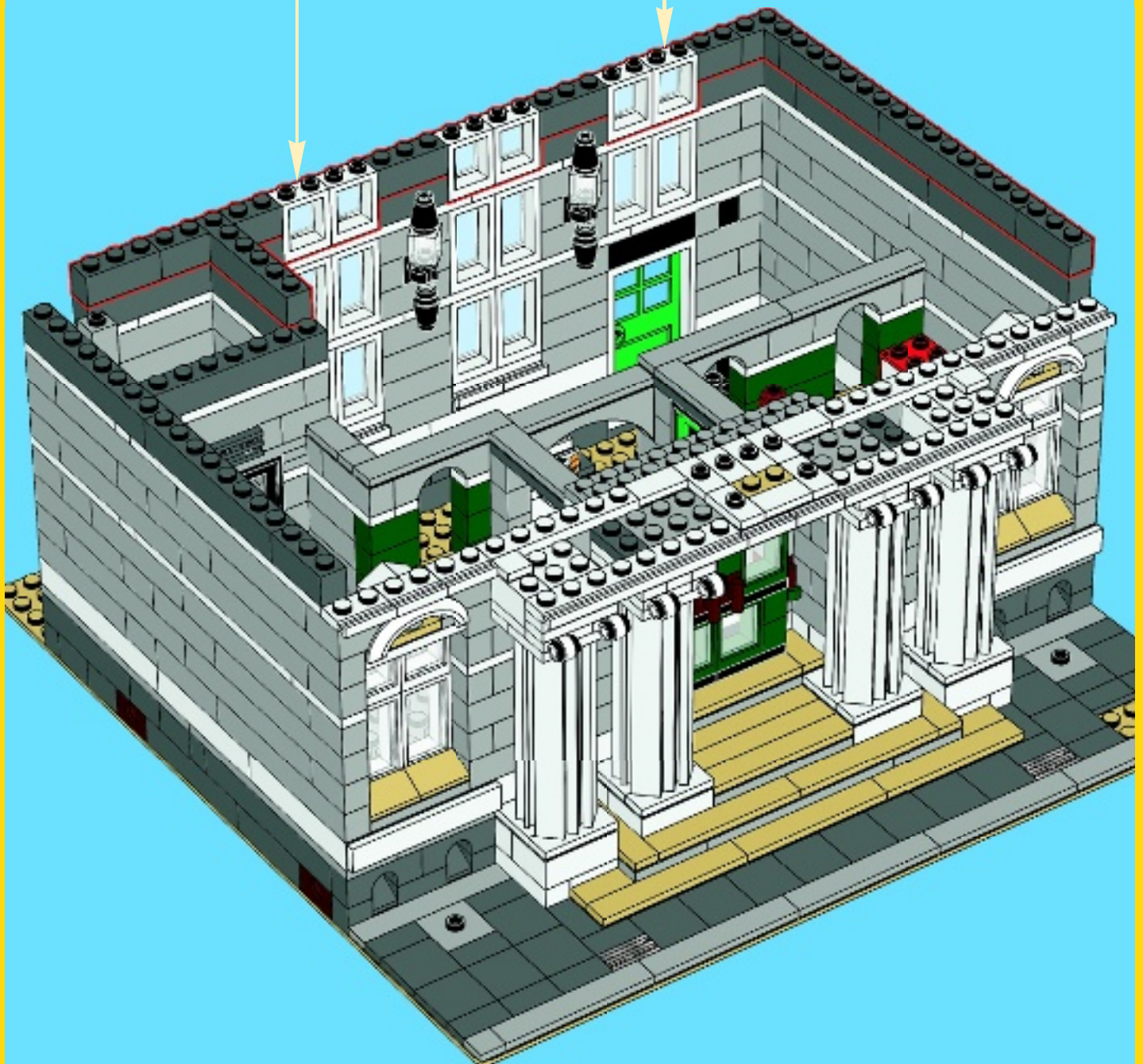

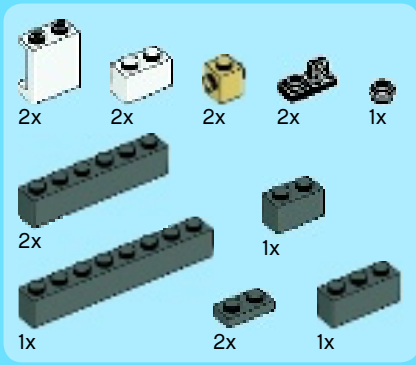

48

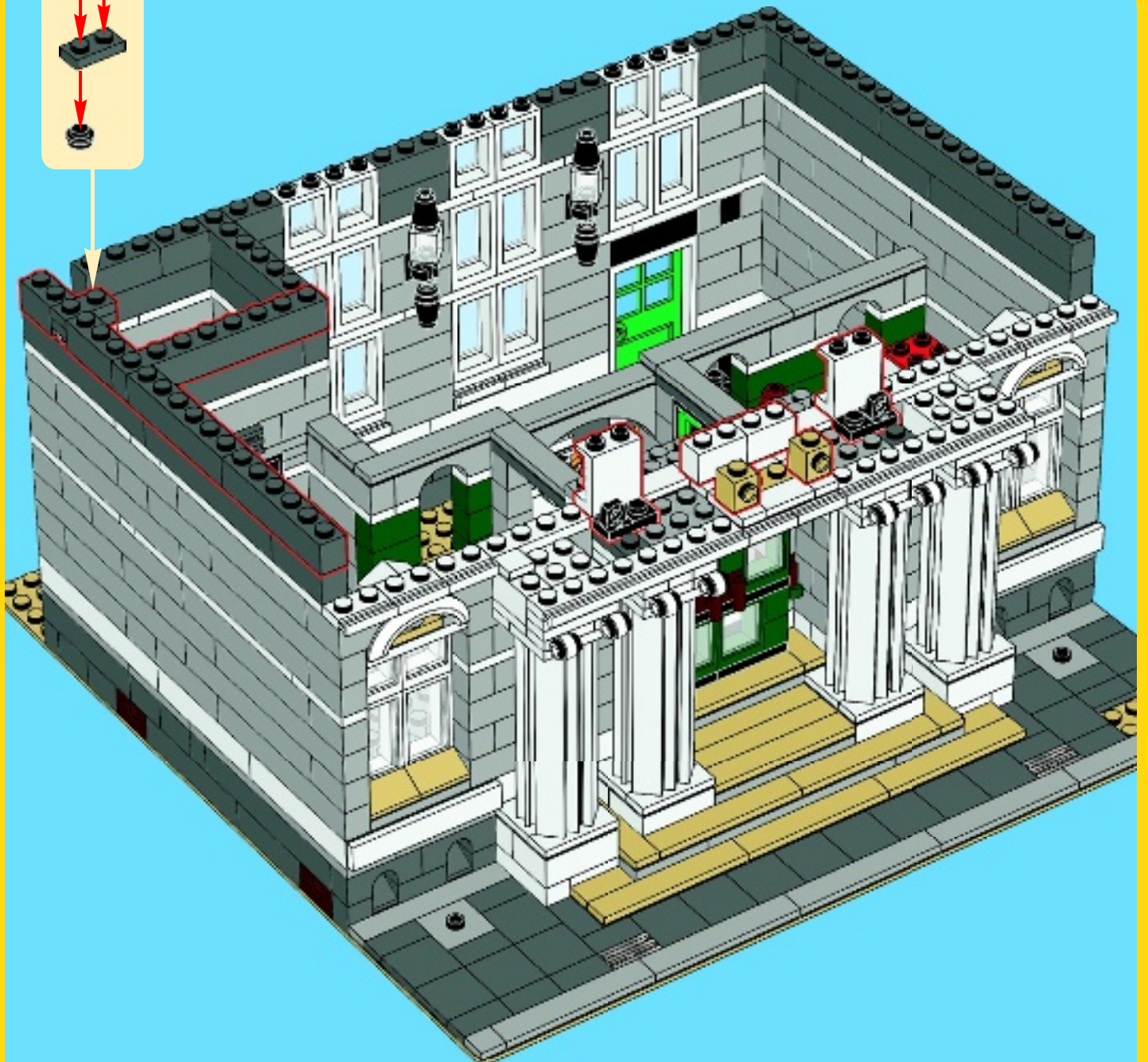
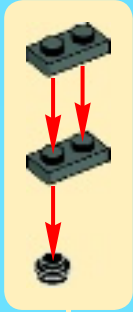

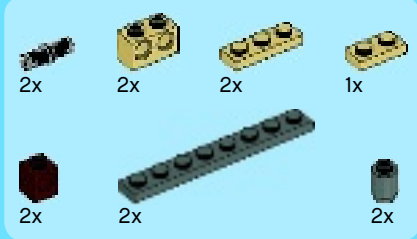

49

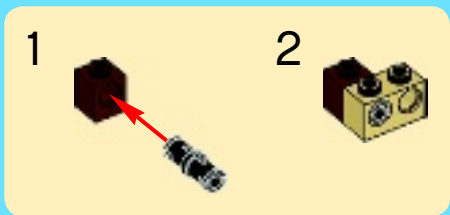
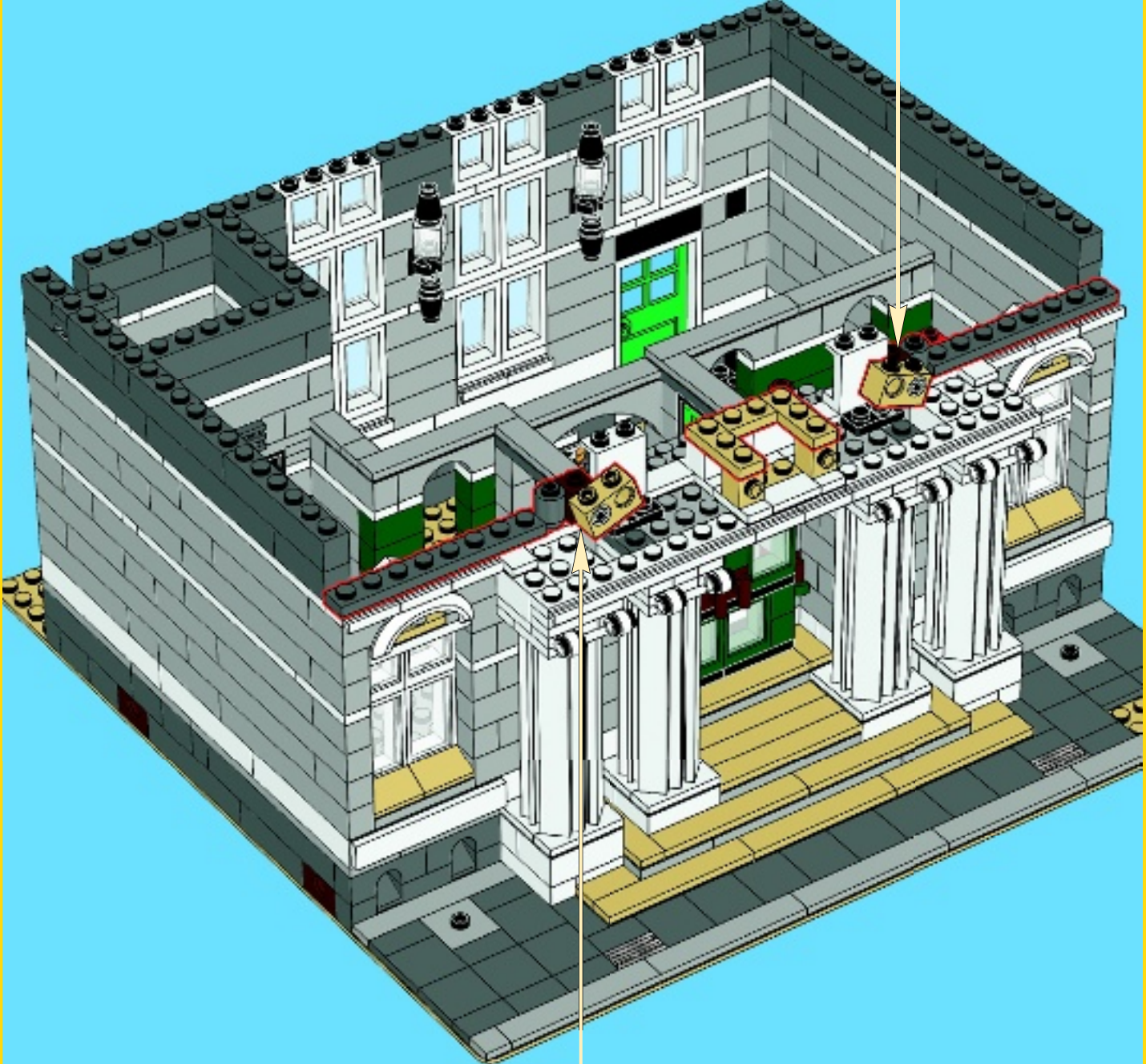

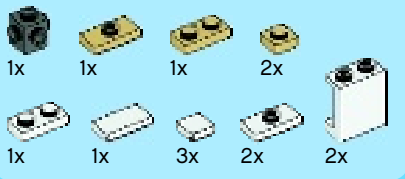

50

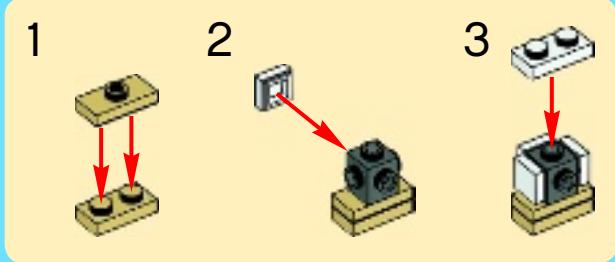
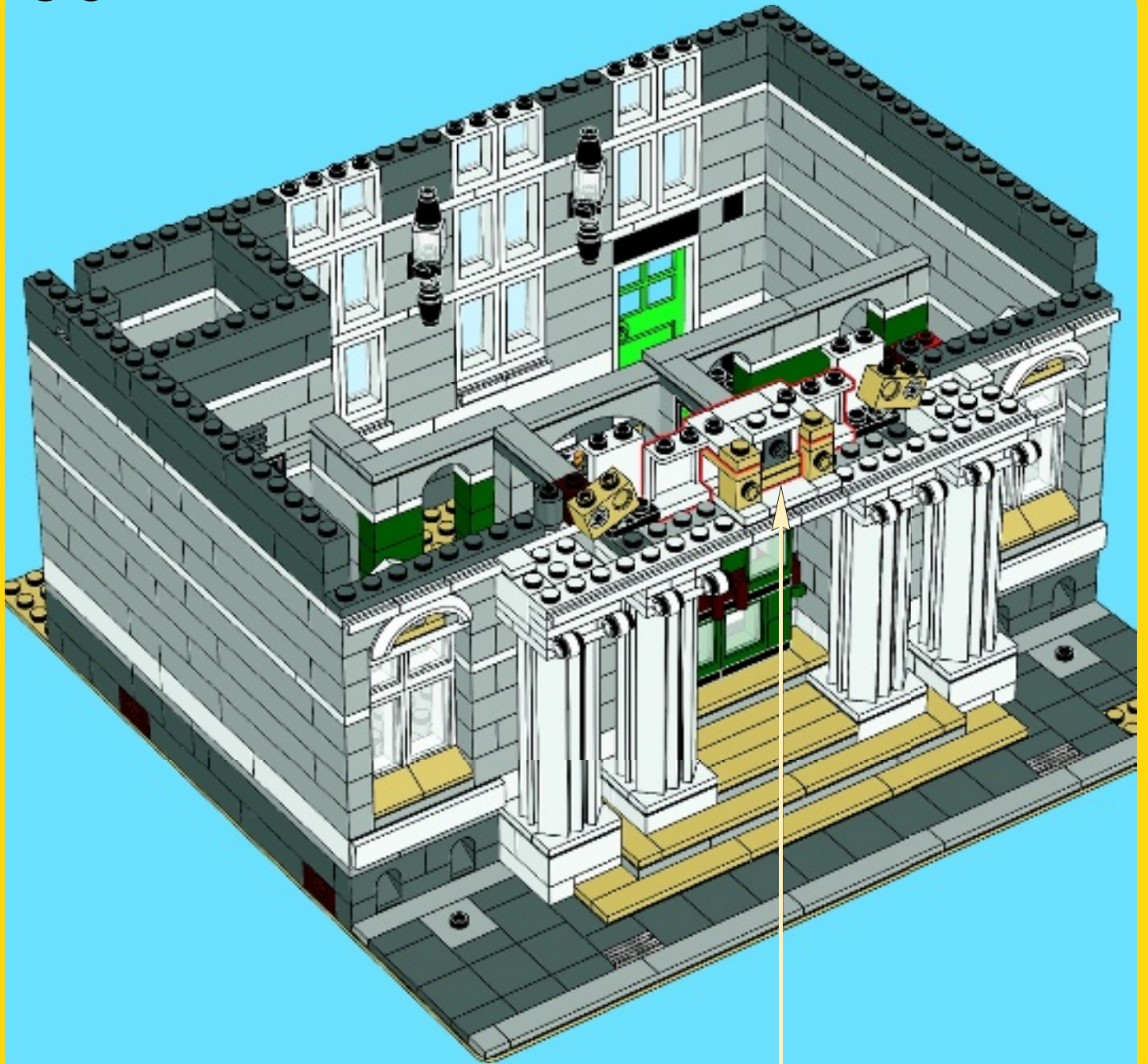

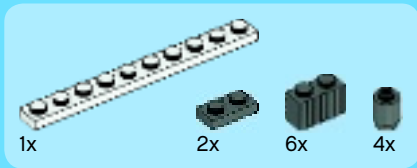

51

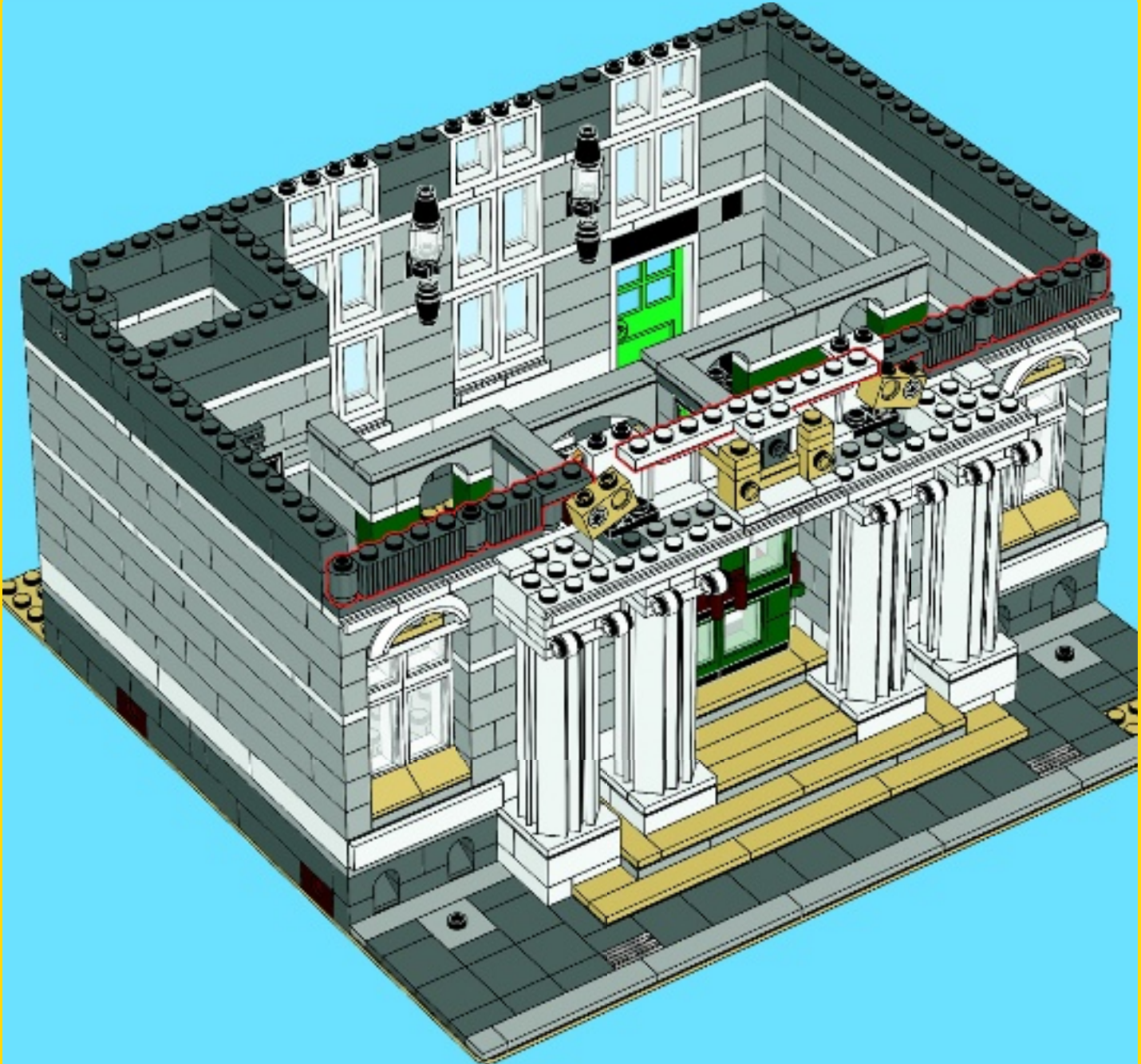

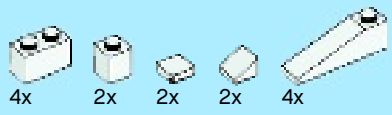

52

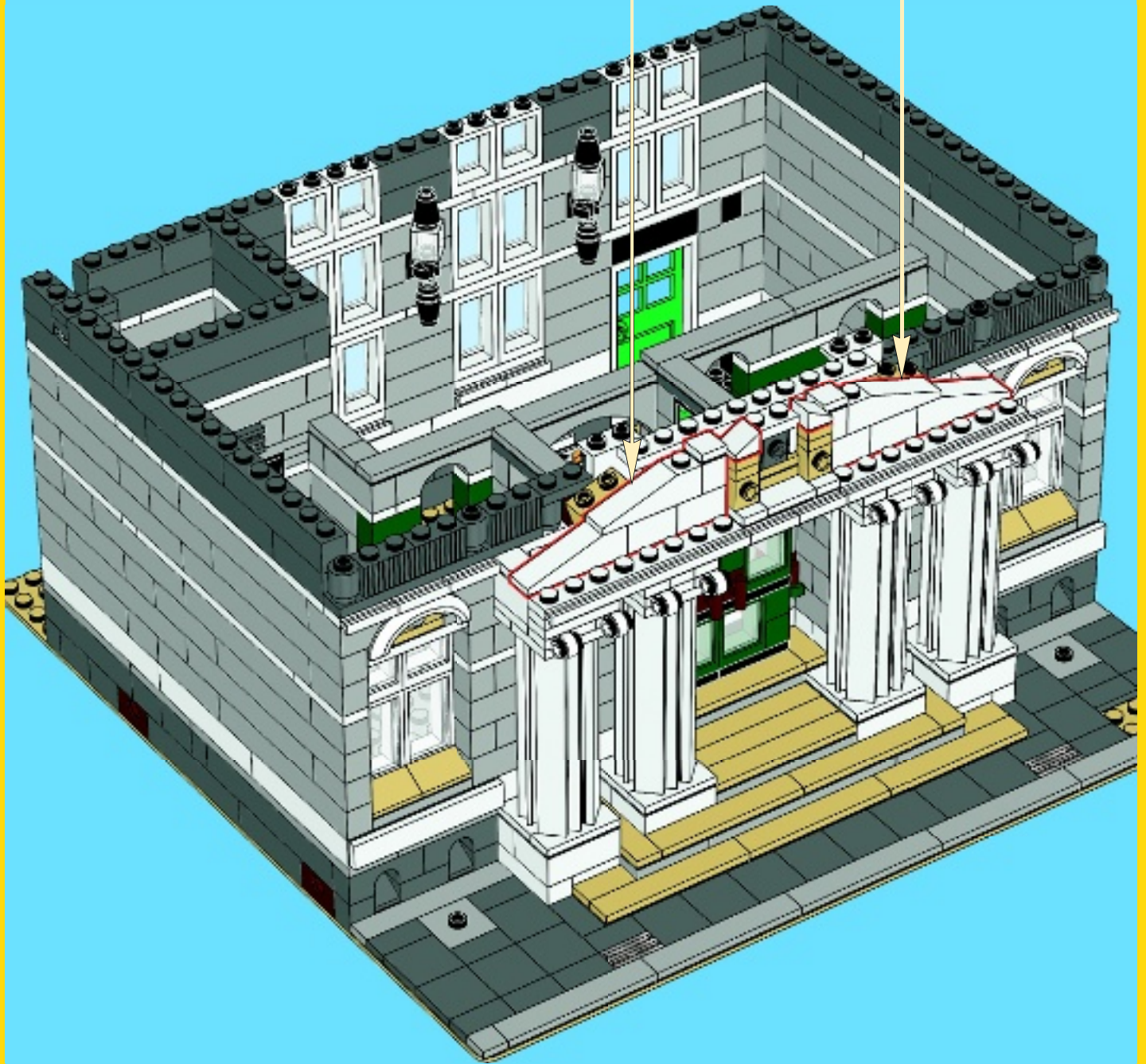
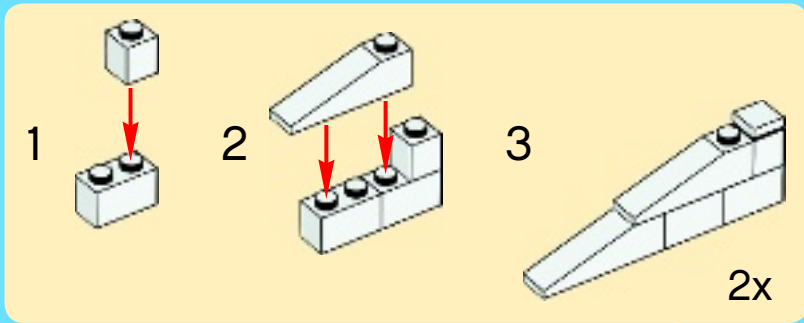

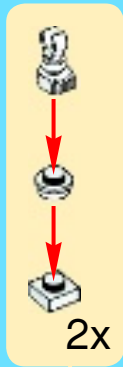
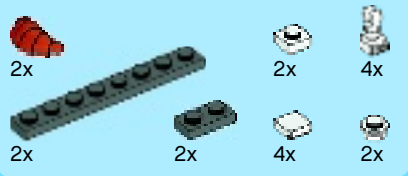

53

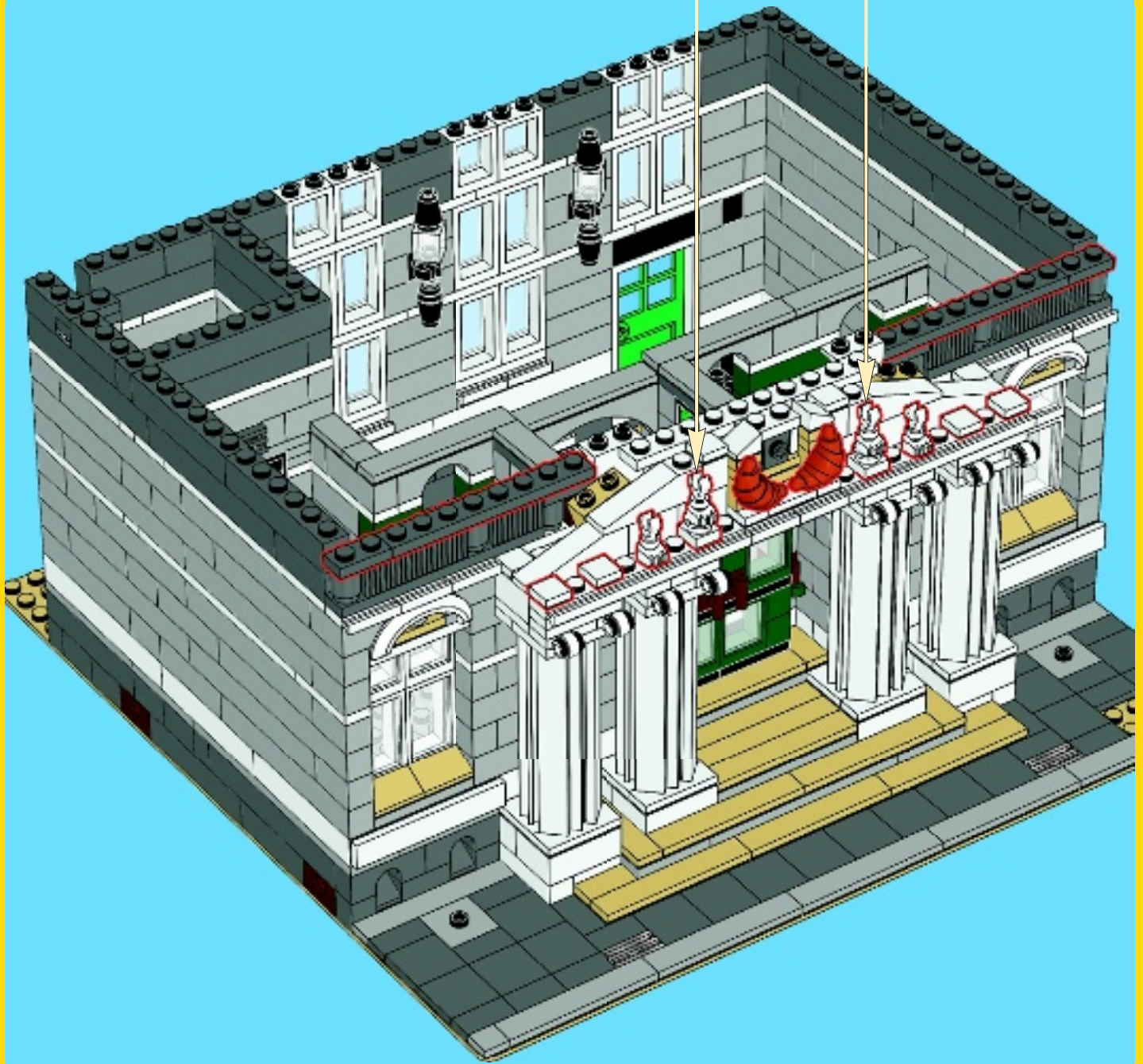

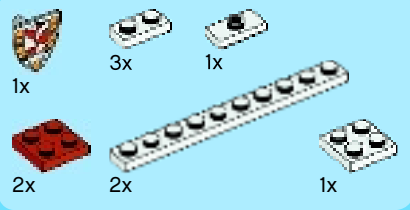

54

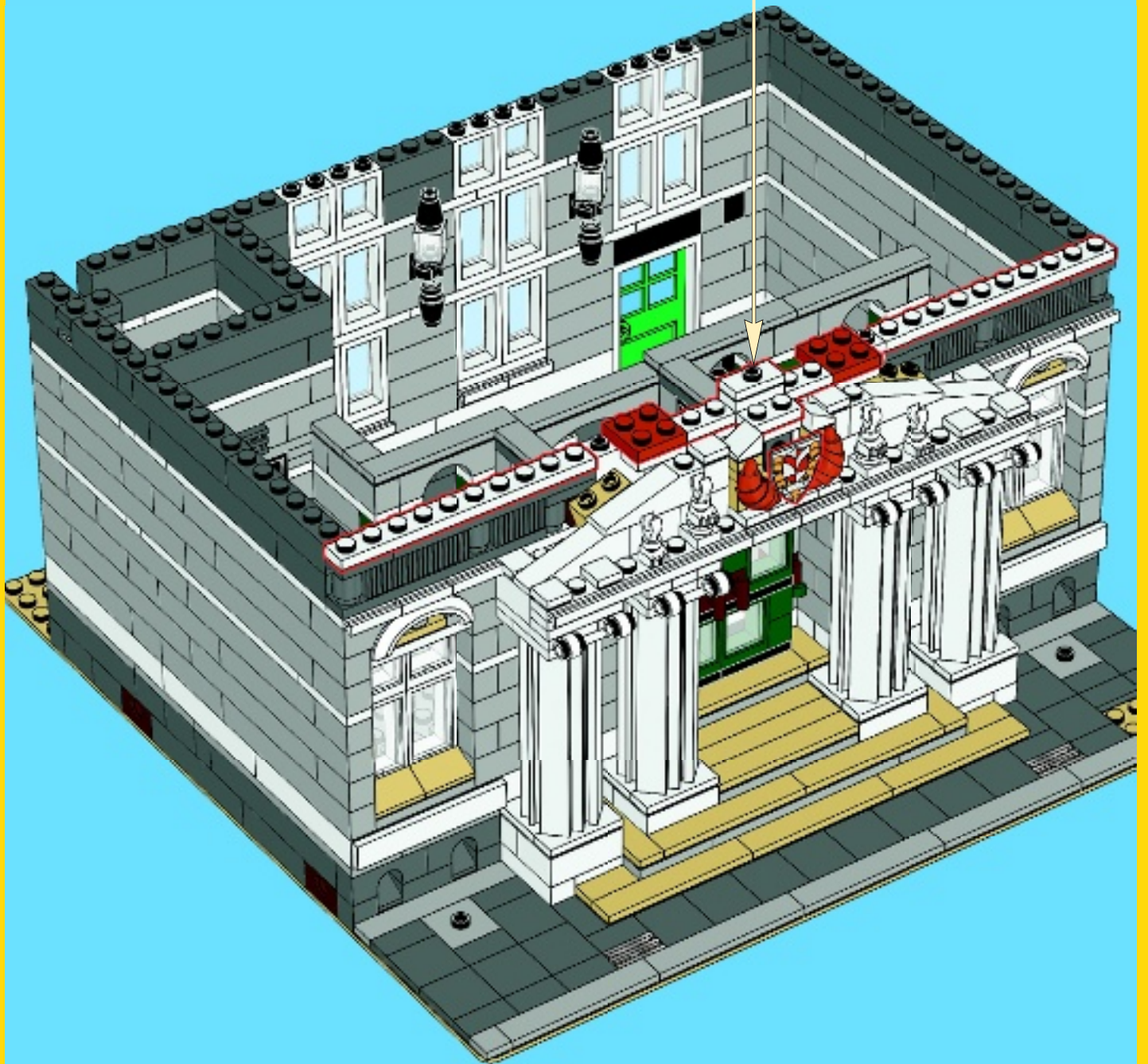
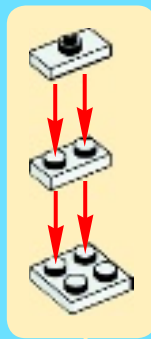

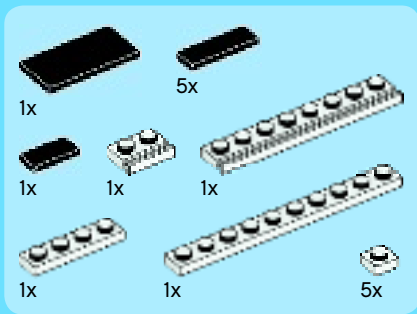

55

1

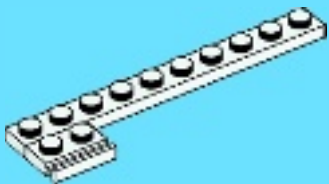

2

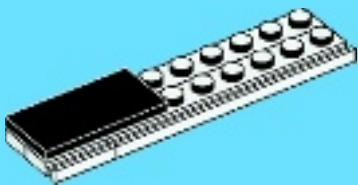

3

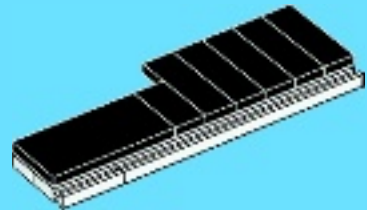

4

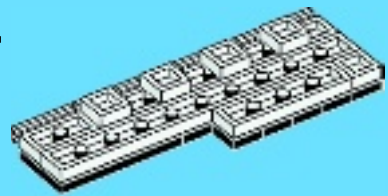

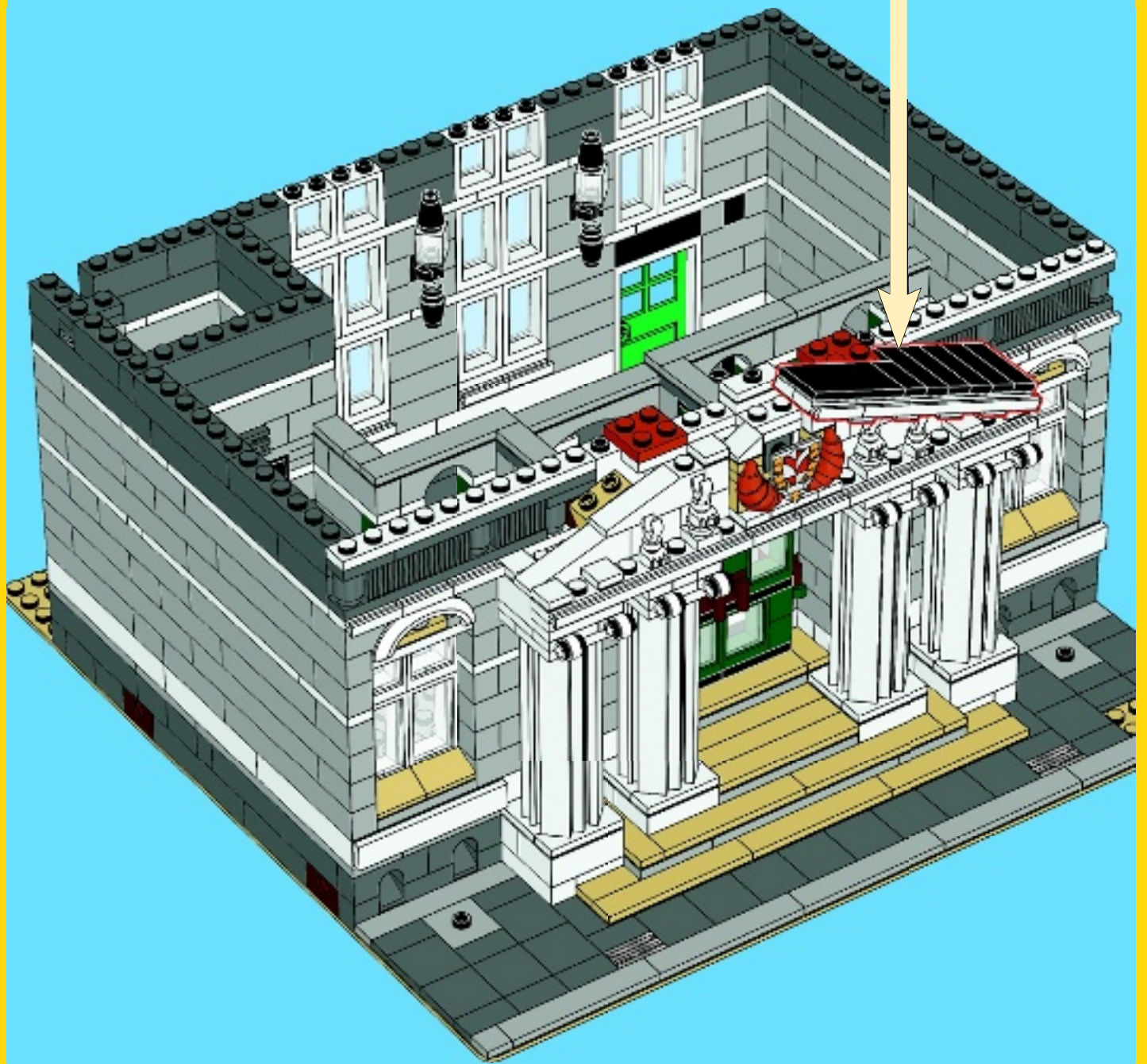

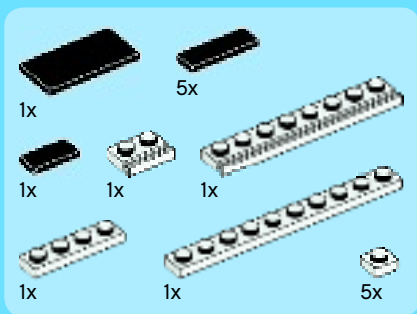

56

1

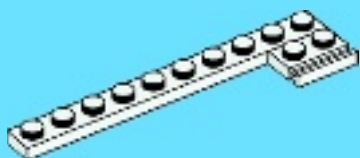

2



3

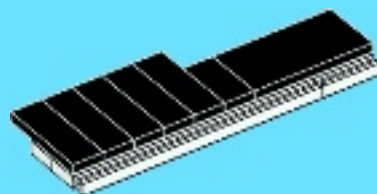

4

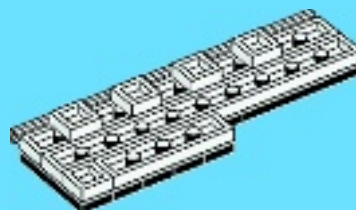

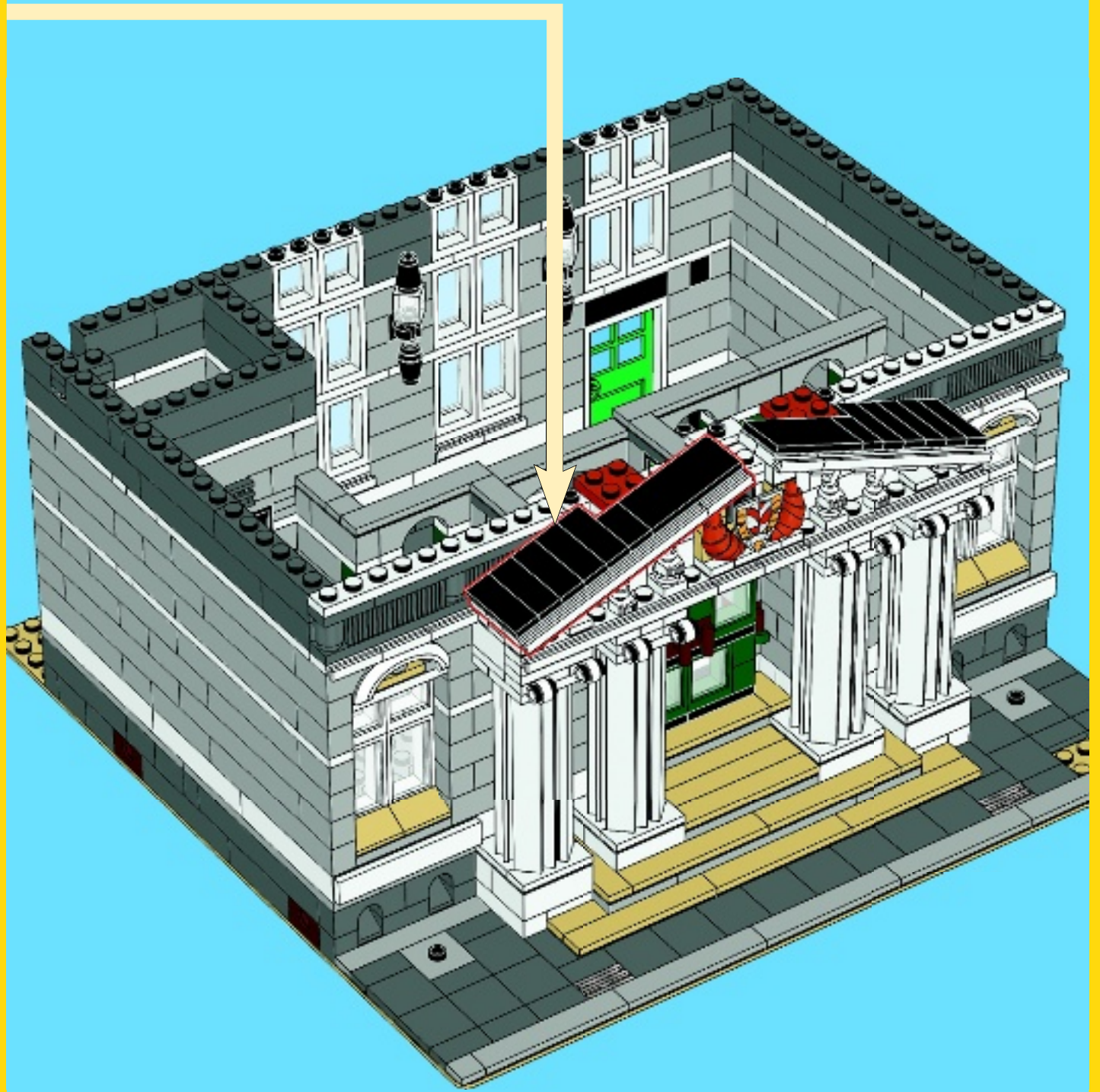

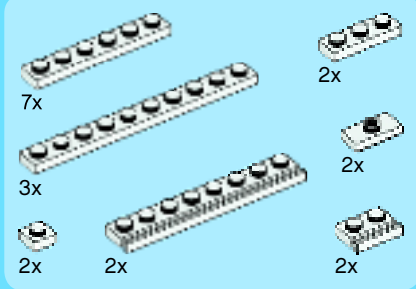

57

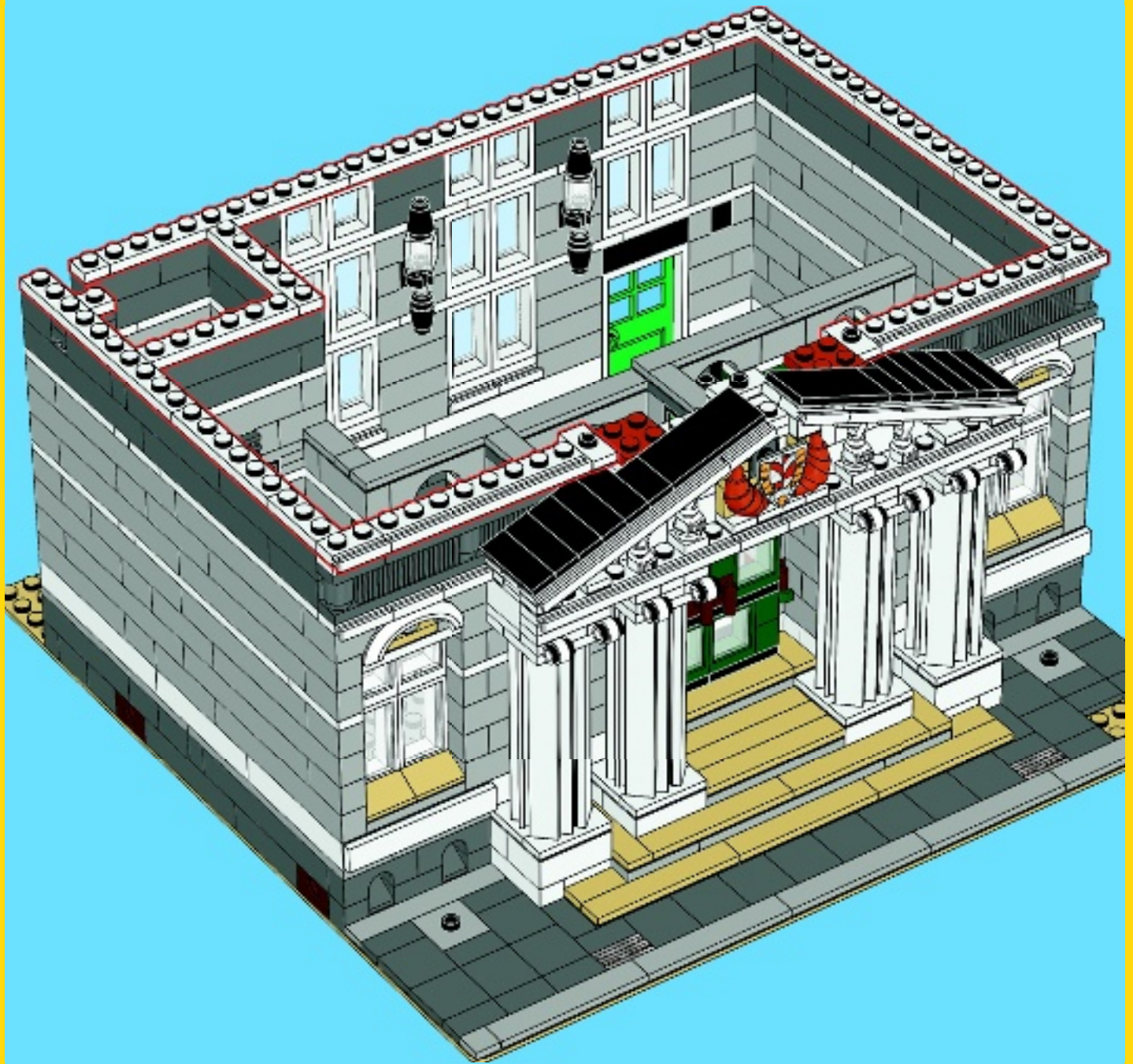

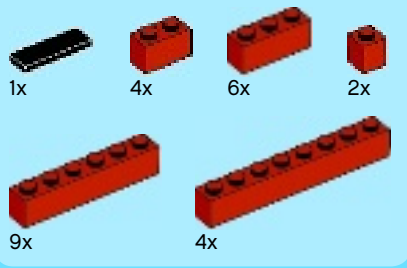

58

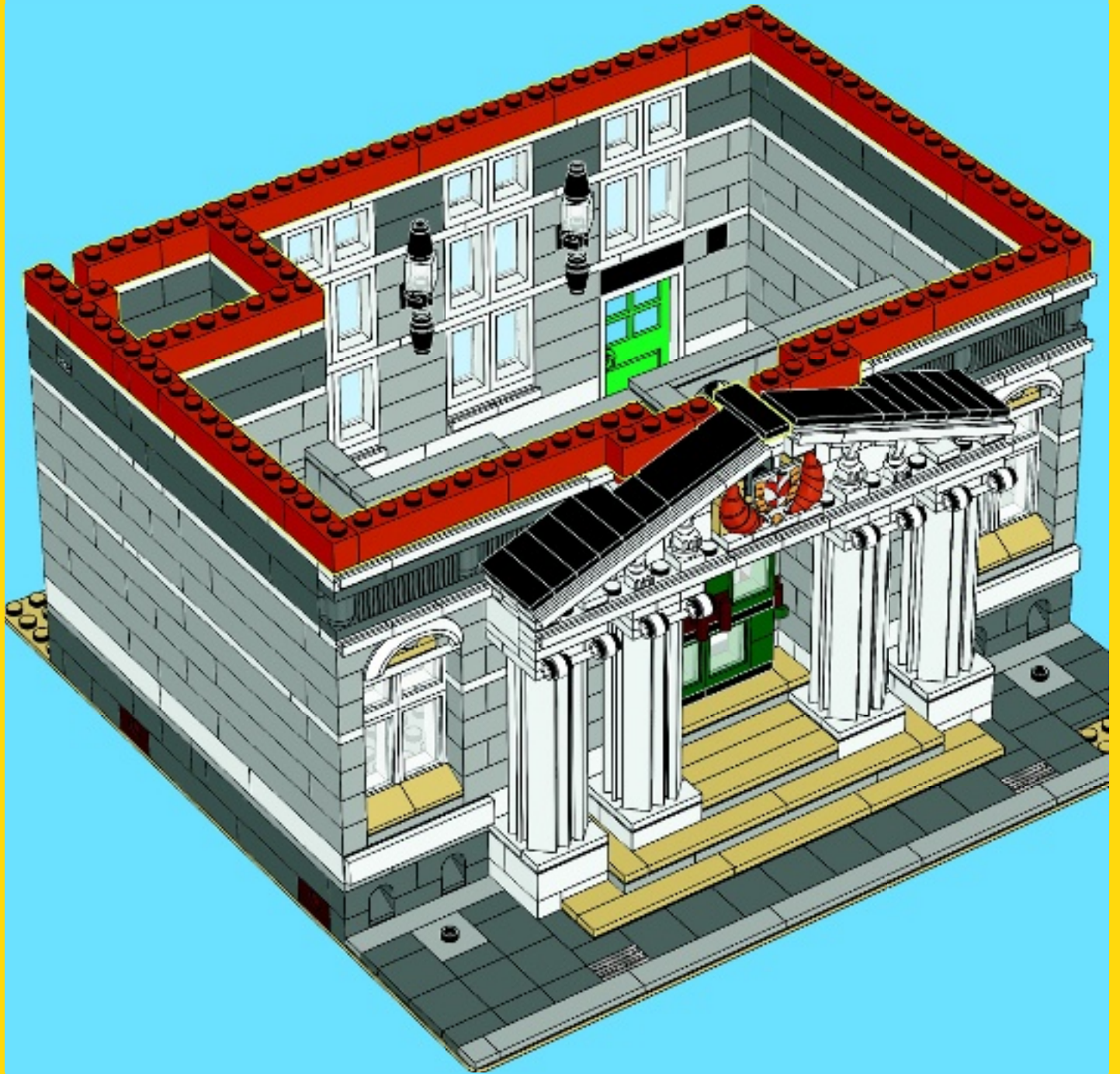

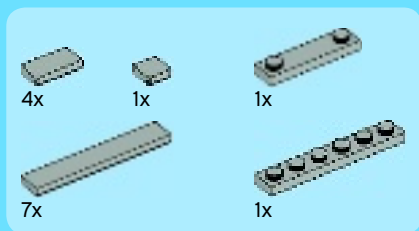

59

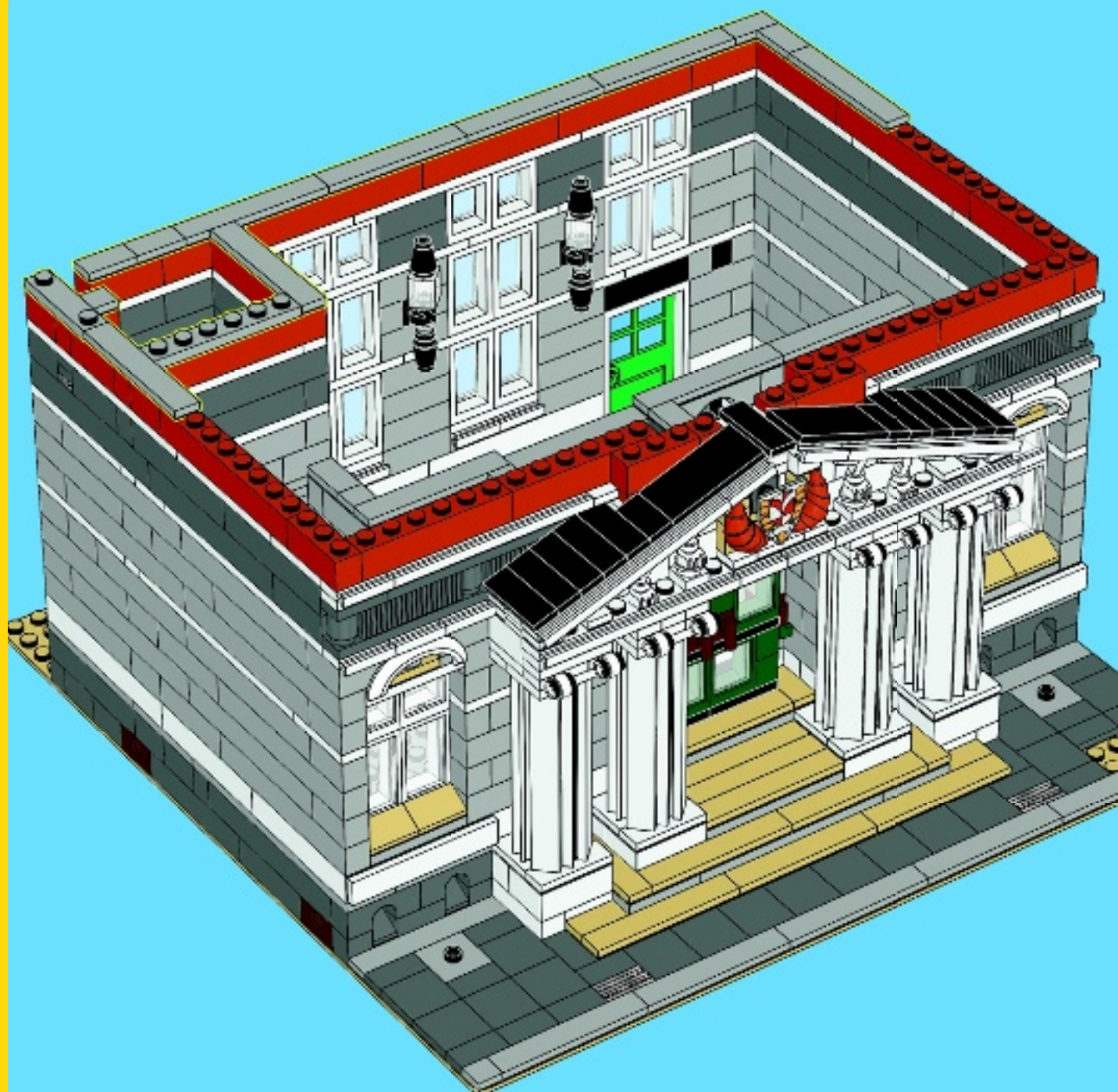

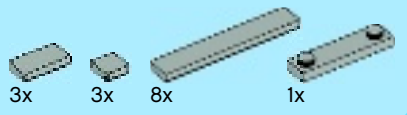

60

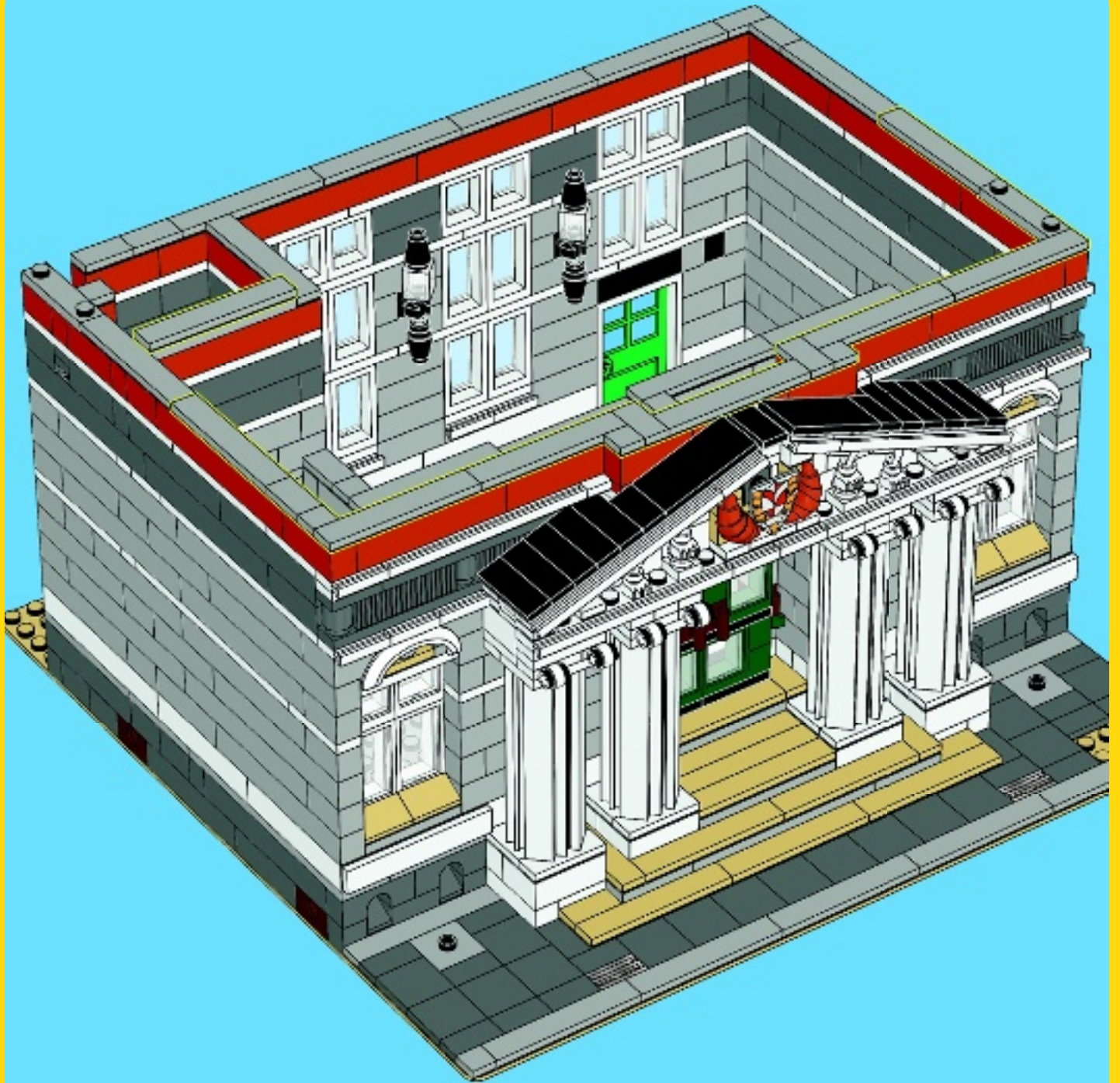

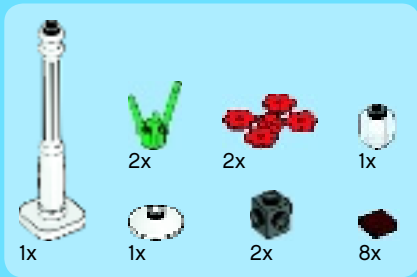

61

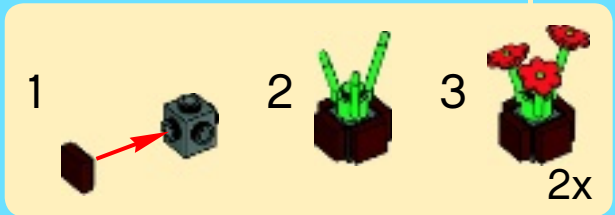
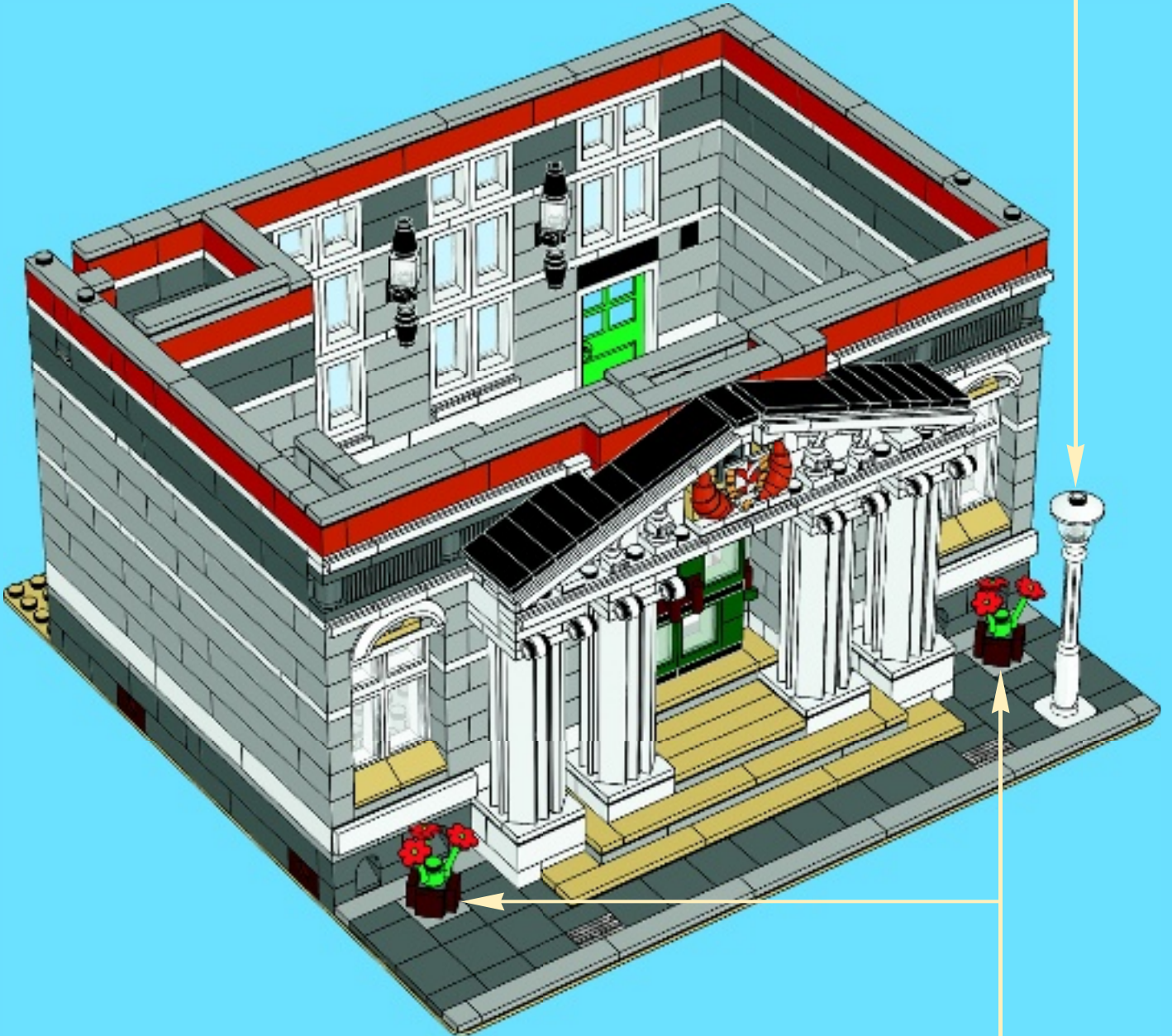
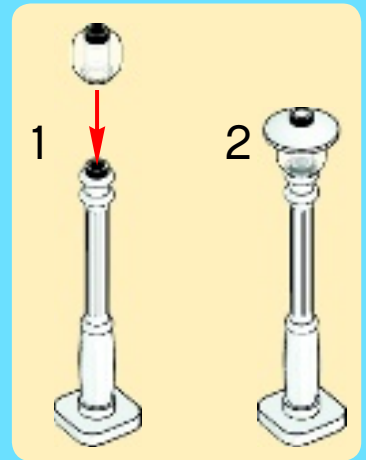

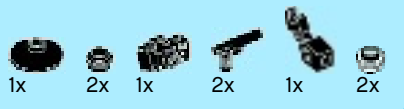

62

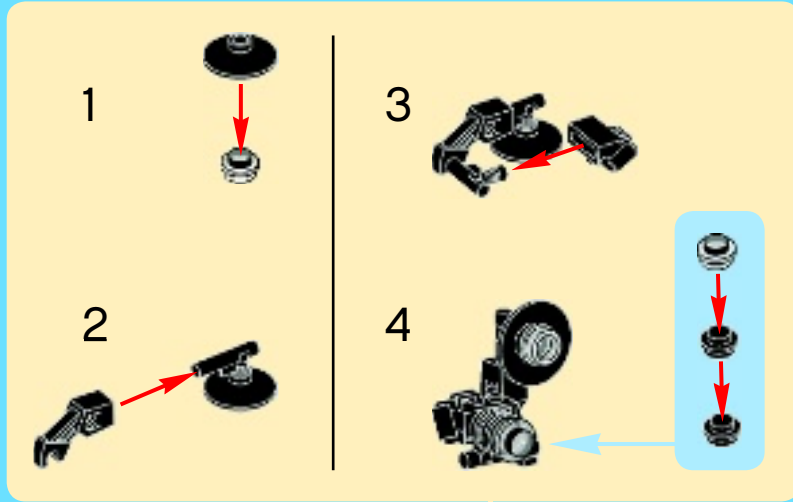

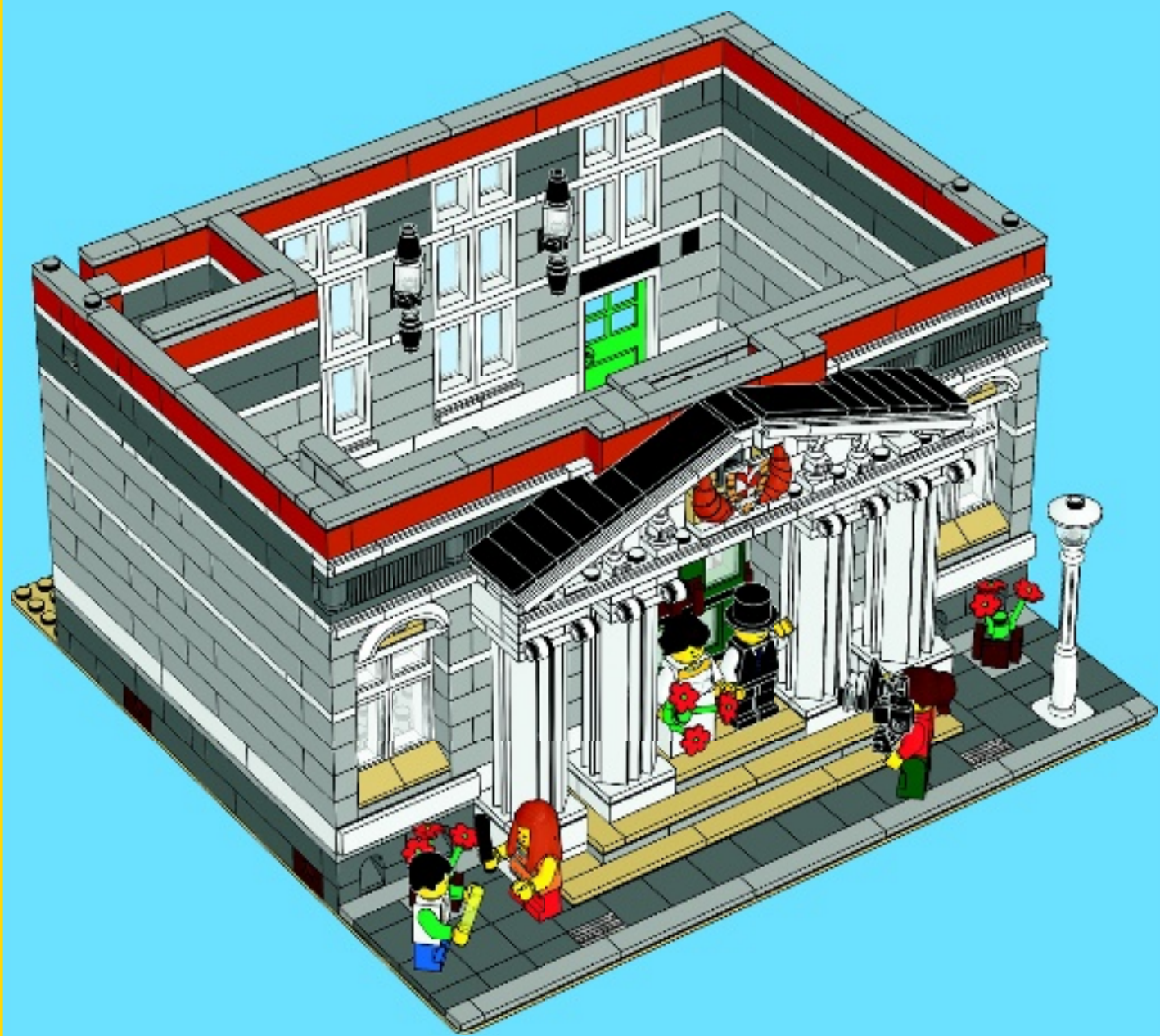

10211

10218

10224

